



# NEUTRONS AND THEIR INTERACTION WITH MATTER

# NEUTRONS AND THEIR INTERACTION WITH MATTER

## Overview

- *History – neutrons and nuclear reactions*
- *Production – reactors and spallation sources*
  - *Properties – as a particle and a probe*
- Instruments – exploiting the probe to do science

# A BIT OF HISTORY

## The neutron

- 1932: J. Chadwick, after work by others, discovers the 'neutron', a neutral but massive particle

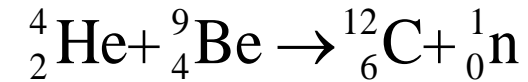

$$(m_{\text{He}} + m_{\text{B}})c^2 + T_{\text{He}} = (m_{\text{C}} + m_{\text{n}})c^2 + T_{\text{C}} + T_{\text{n}}$$

$$m_{\text{n}} = 1.0067 \pm 0.0012 \text{ a.m.u}$$

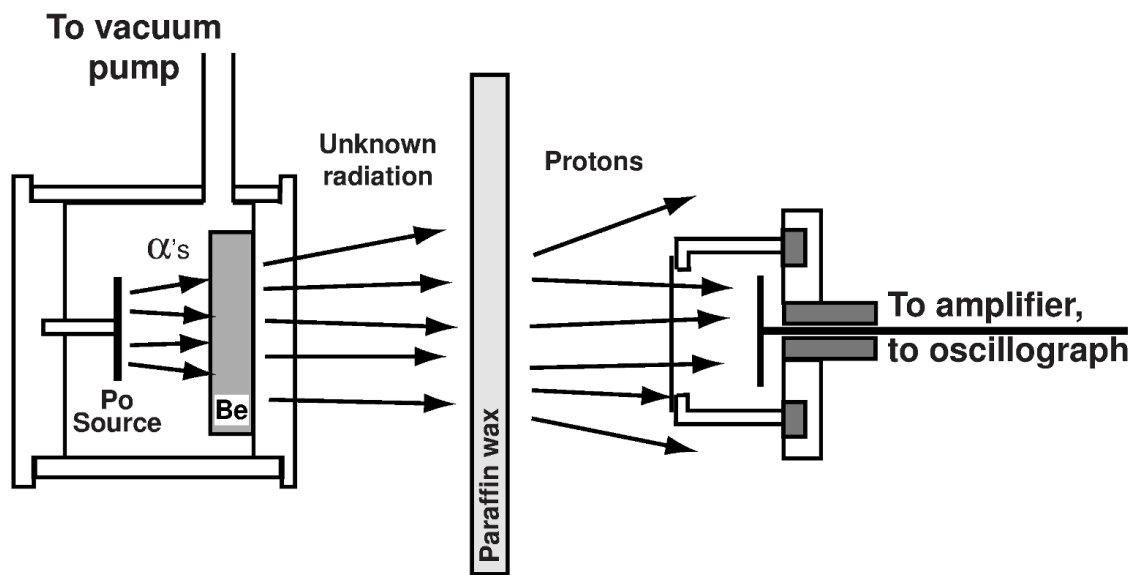



# A BIT OF HISTORY

## The nuclear reaction

- 1938: O. Hahn, F. Strassmann & L. Meitner discovered the fission of  $^{235}\text{U}$  nuclei through thermal neutron capture
- 1939: H. v. Halban, F. Joliot & L. Kowarski showed that  $^{235}\text{U}$  nuclei fission produced 2.4 neutrons on average – chain reaction
- 1942: E. Fermi & al. demonstrated first self-sustained chain reaction reactor

Chicago pile:  
360T of graphite  
50T of U and UO  
0.5W power







# NOBEL PRIZES, NEUTRONS AND THE ILL

Chadwick, Shull & Brockhouse



*James Chadwick*  
(1891 - 1974)

## The Nobel Prize in Physics 1994

The Royal Swedish Academy of Sciences has awarded the 1994 Nobel Prize in Physics for pioneering contributions to the development of neutron scattering techniques for studies of condensed matter.



**Clifford G. Shull**, MIT, Cambridge, Massachusetts, USA, receives one half of the 1994 Nobel Prize in Physics for development of the neutron diffraction technique.

**Shull** made use of **elastic scattering** i.e. of neutrons which change direction without

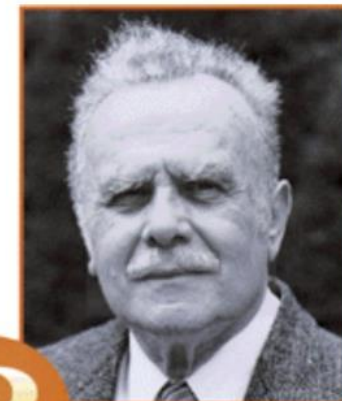

**Betram N. Brockhouse**, McMaster University, Hamilton, Ontario, Canada, receives one half of the 1994 Nobel Prize in Physics for the development of neutron spectroscopy.

**Brockhouse** made use of **inelastic scattering** i.e. of neutrons, which change



# NOBEL PRIZES, NEUTRONS AND THE ILL

Louis Néel  
(Grenoble) -  
magnetism





# NOBEL PRIZES, NEUTRONS AND THE ILL

Haldane (1977 – 1981), Kosterlitz and Thouless for topological phase transitions and phases of matter (Electronic structure and excitation of 1D quantum liquids and spin chains)

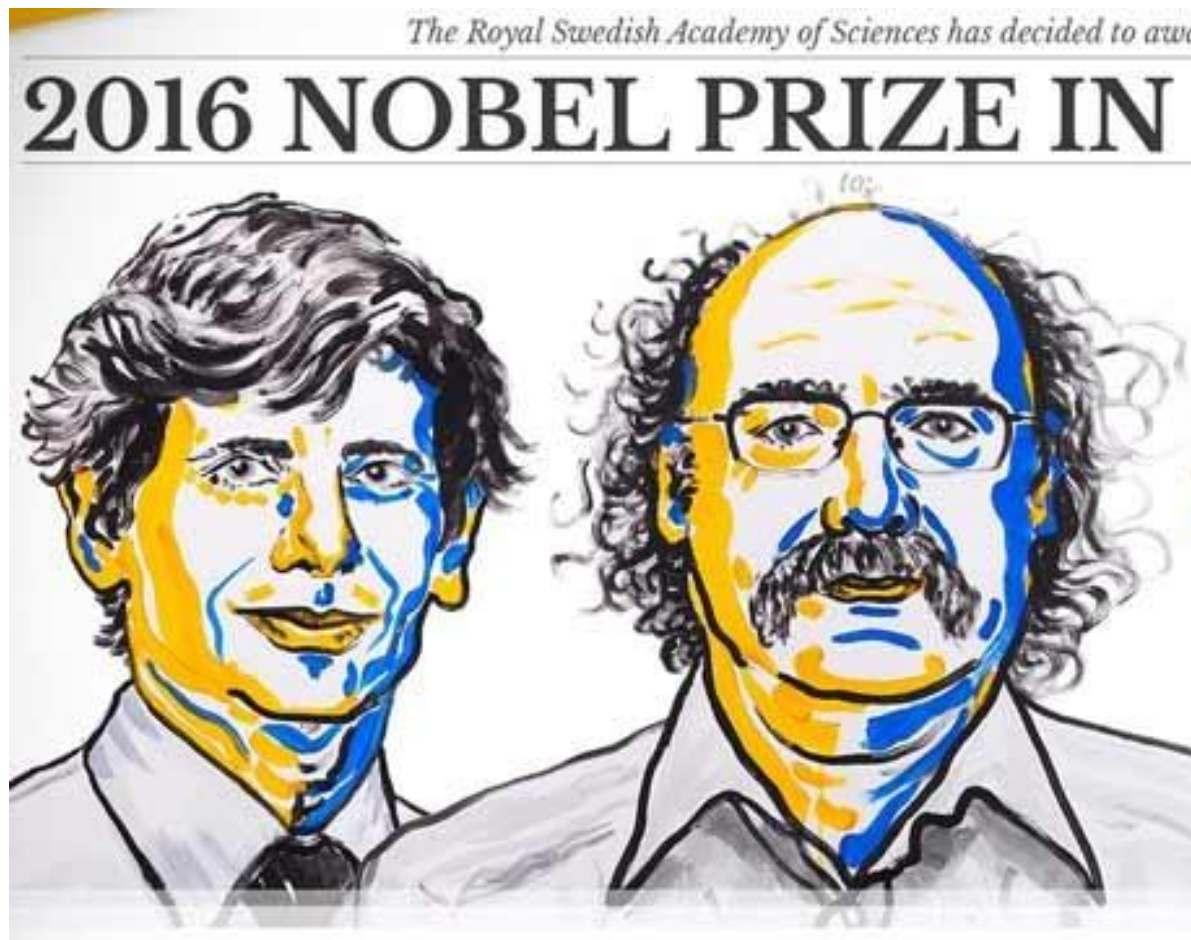

THE NOBEL PRIZE  
IN PHYSICS 2022

Illustrations: Niklas Elmehed

Alain Aspect      John F. Clauser      Anton Zeilinger

“for experiments with entangled photons, establishing the violation of Bell inequalities and pioneering quantum information science”

THE ROYAL SWEDISH ACADEMY OF SCIENCES

# NEUTRON SOURCES

## Fission reactors

- Nuclear fission → chain reaction with excess neutrons ( $1n \rightarrow 2.5n$ )
- Slow neutrons split U-235 nuclei
- Fission neutrons have MeV energies and need to be moderated (thermalized) to meV energies by scattering from water
- Thermalisation @ RT → *thermal* neutrons, @ 25K → *cold* neutrons and @ 2400 K → *hot* neutrons
- ILL – flux  $1.5 \times 10^{15}$  n/cm<sup>2</sup>/s

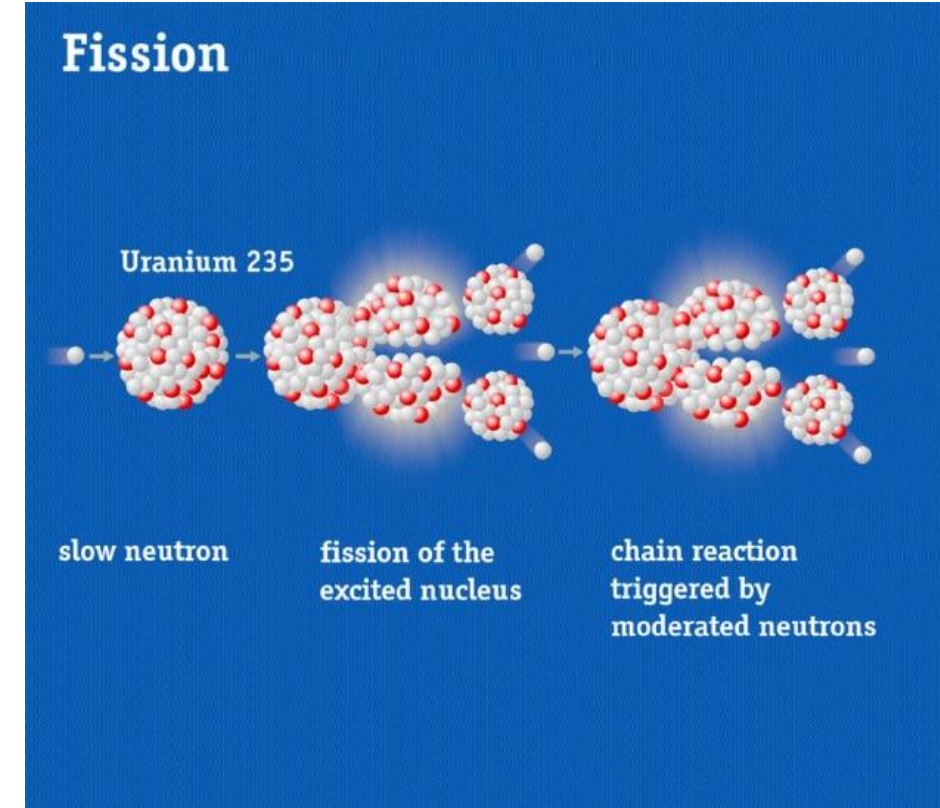



# NEUTRON SOURCES

## Spallation sources

- Neutrons can be produced by bombarding heavy metal targets
- 2 GeV protons (90% speed-of-light) produce spallation – evaporation of  $\sim 30$  neutrons

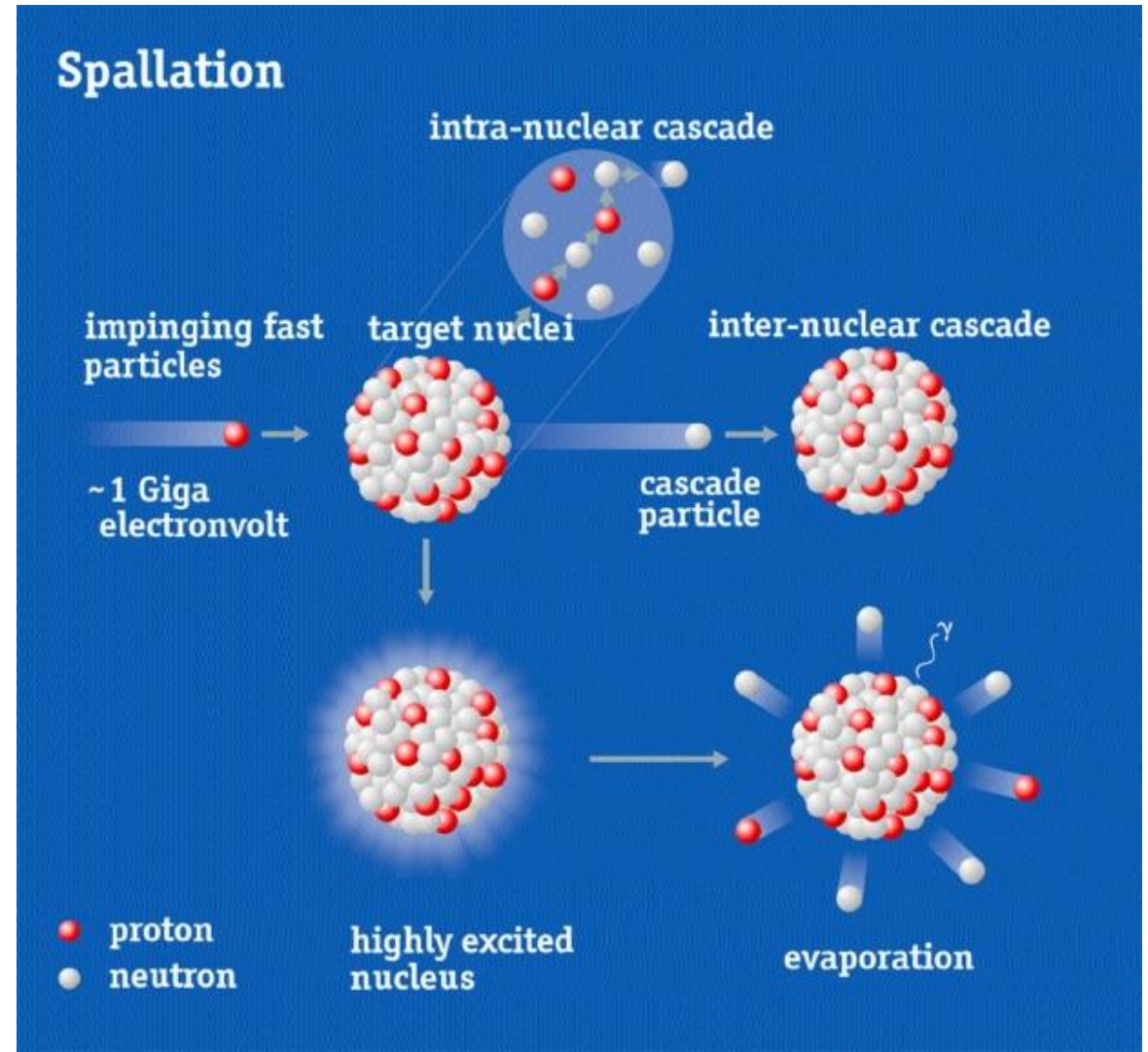



# NEUTRON SOURCES

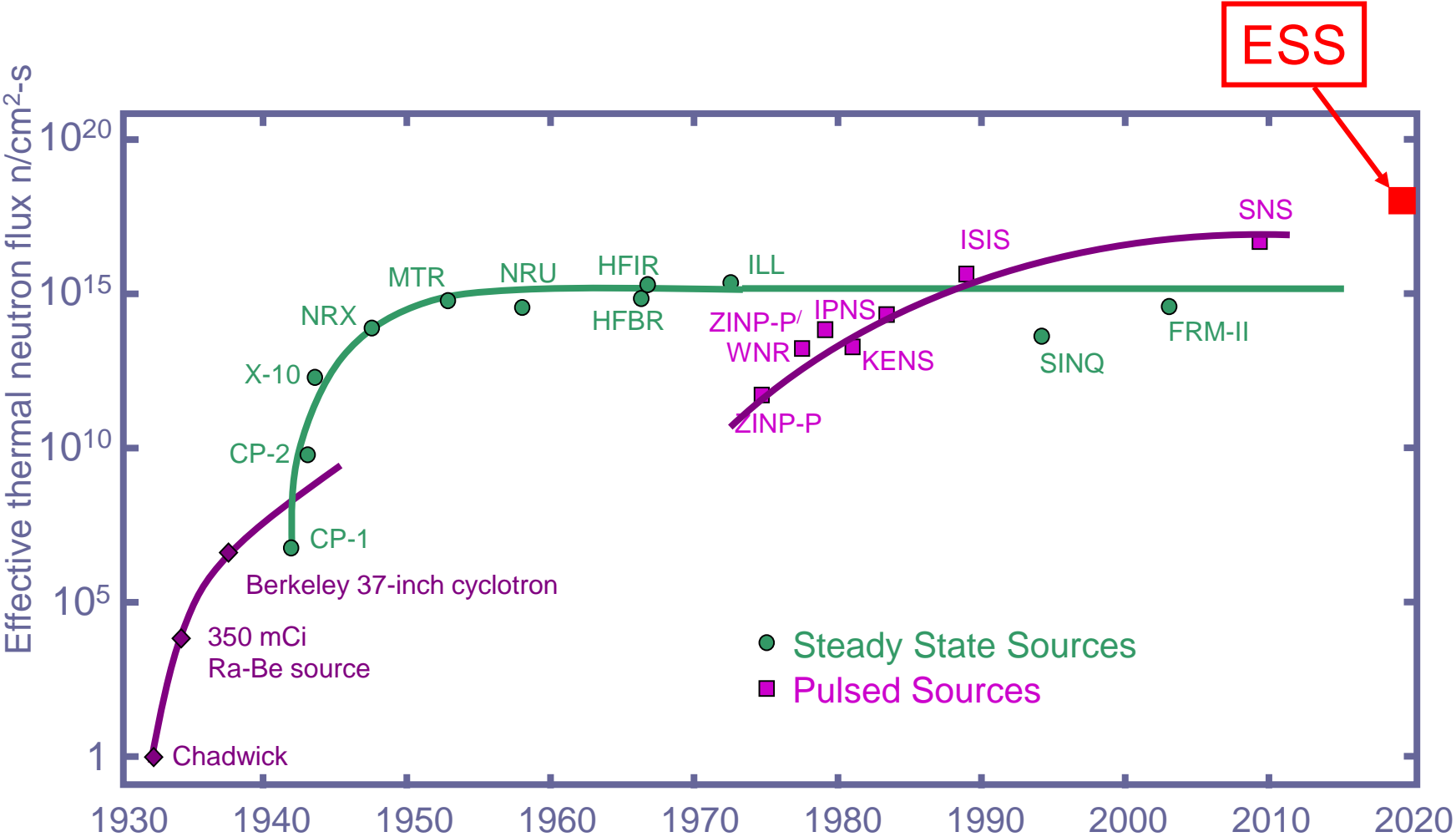

(Updated from *Neutron Scattering*, K. Skold and D. L. Price, eds., Academic Press, 1986)

# CONTINUOUS OR PULSED BEAMS

Integrated vs peak flux – ESS will have a time-integrated flux comparable to ILL

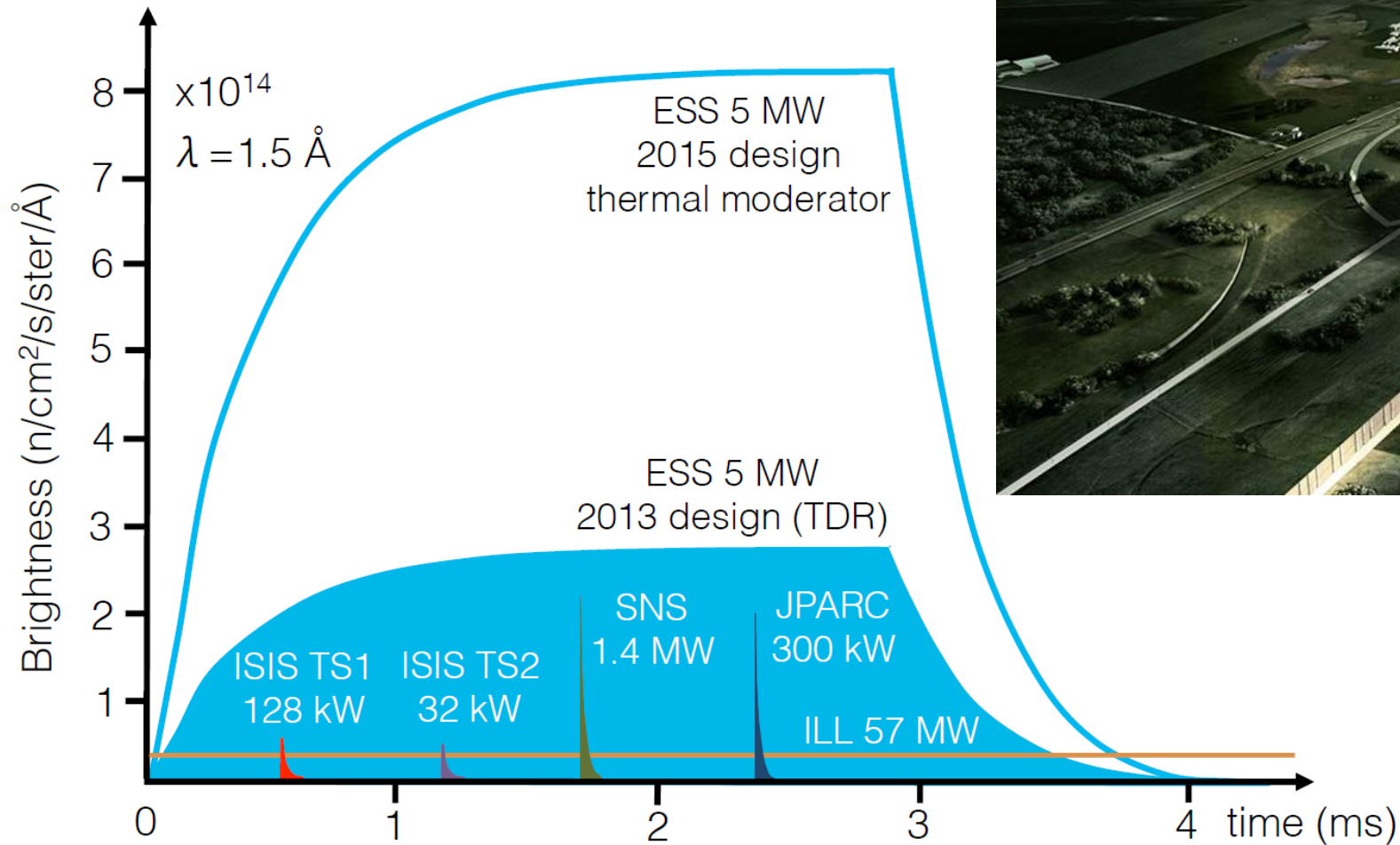



# CONTINUOUS OR PULSED BEAMS

Integrated vs peak flux – ESS will have a time-integrated flux comparable to ILL

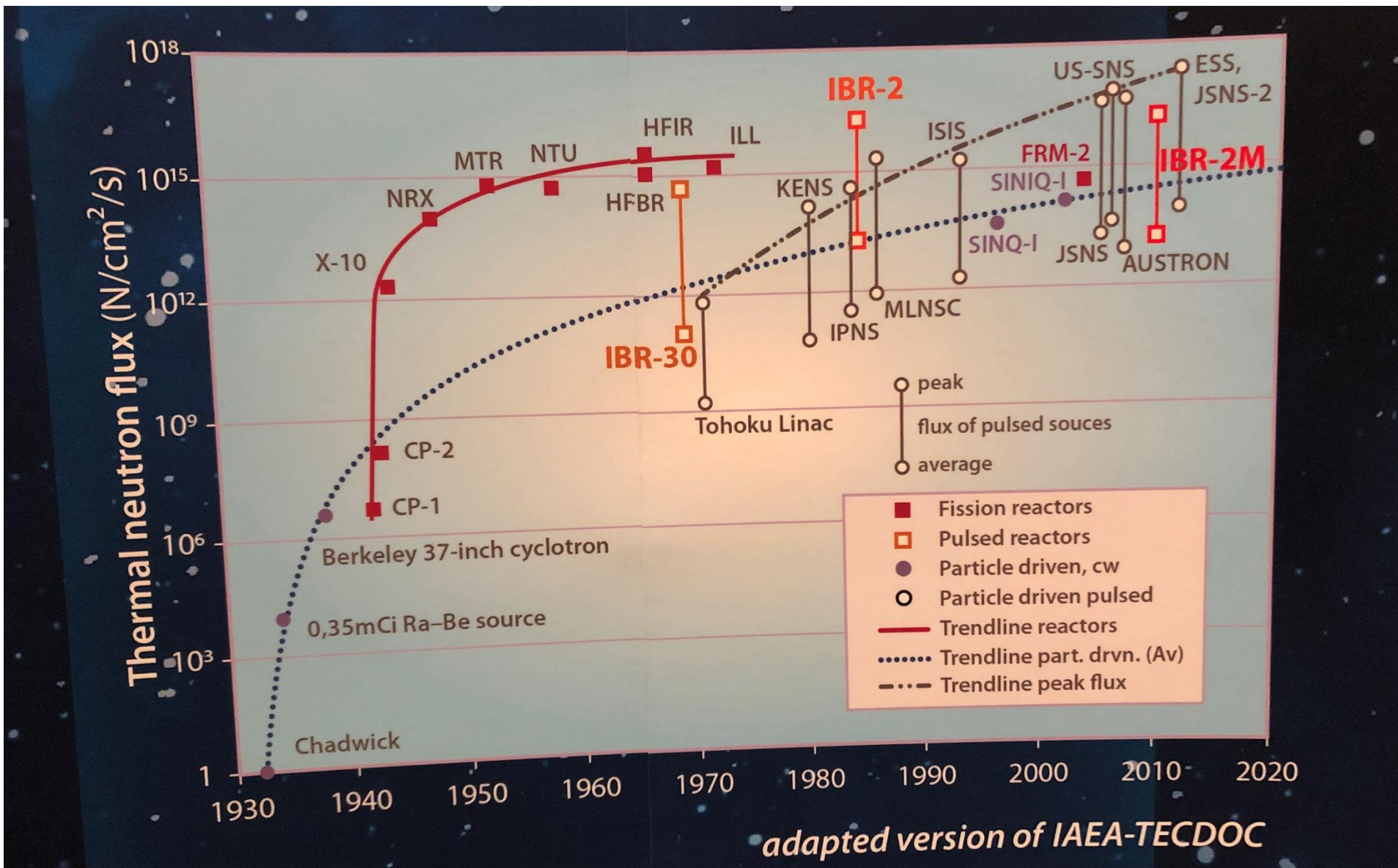



# N vs X

ESRF (hard X-rays)

- Exponential development contrasts with development of neutron sources

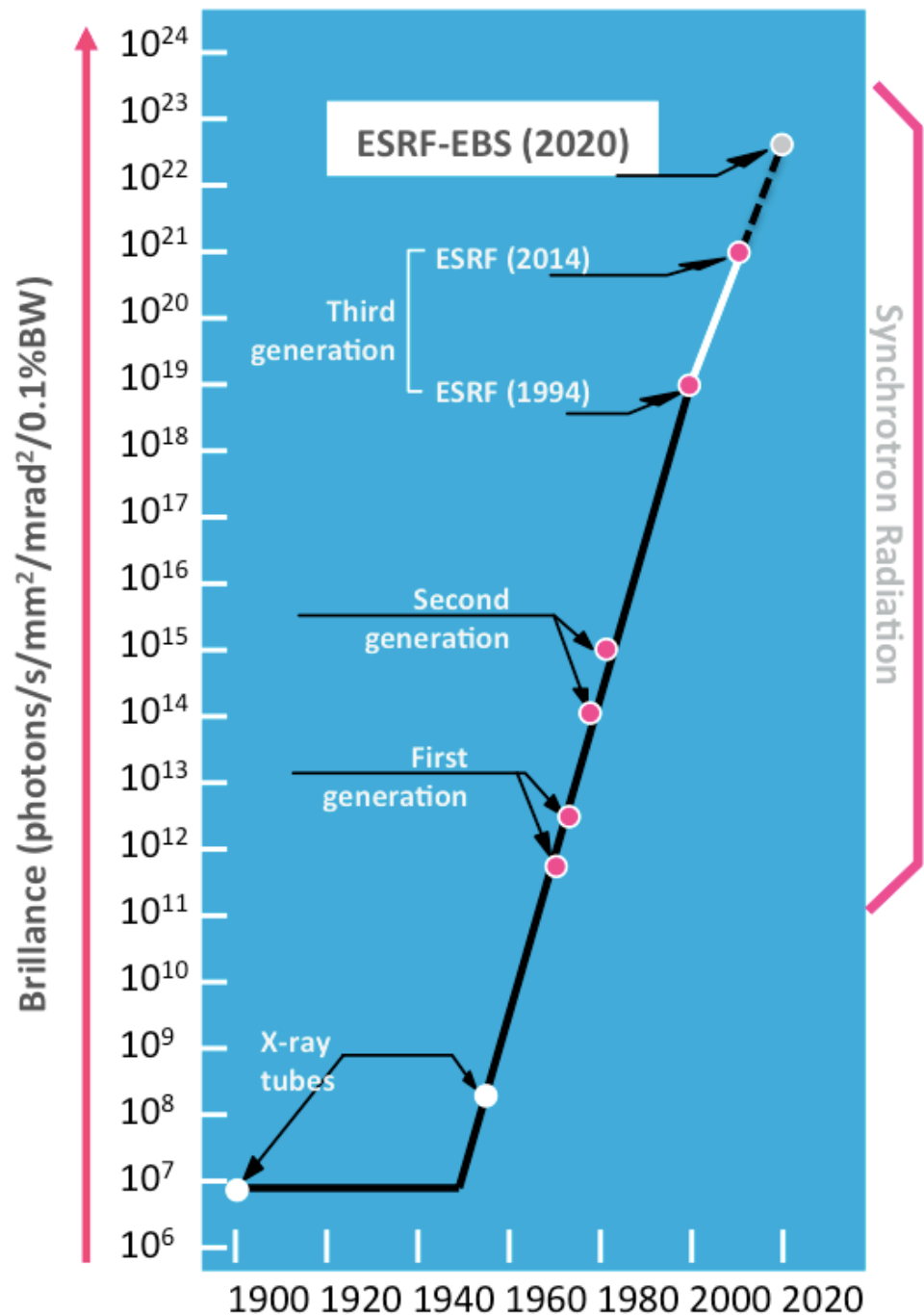

# N & X

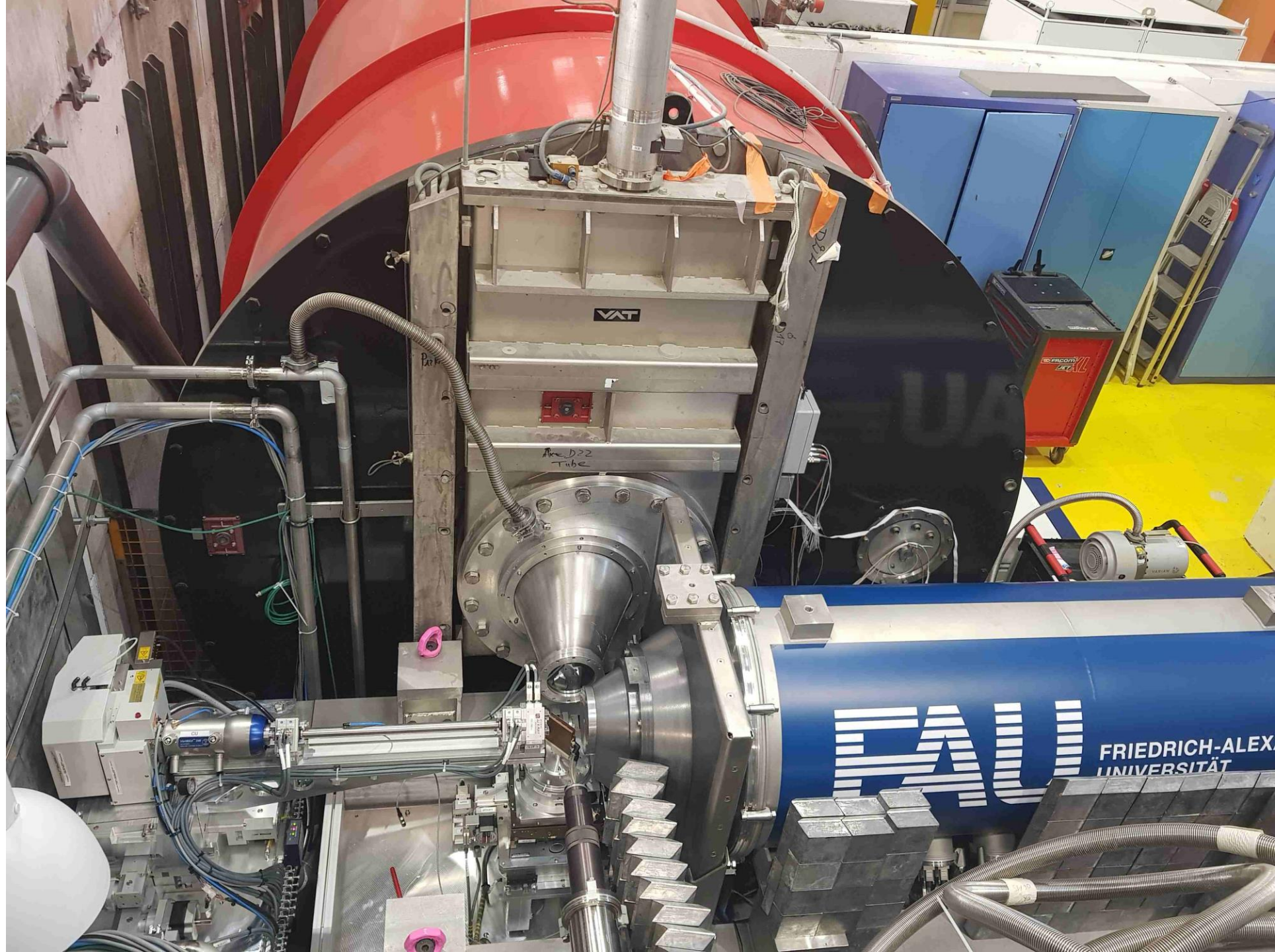

08/09/2023



# THE NEUTRON

## As a particle

- free neutrons are unstable:  $\beta$ -decay  $\rightarrow$  proton, electron, anti-neutrino  
life time:  $888 \pm 1$  sec or  $880 \pm 1$  sec
- wave-particle duality: neutrons have particle-like and wave-like properties
- mass:  $m_n = 1.675 \times 10^{-27}$  kg = 1.00866 amu. (unified atomic mass unit)
- charge = 0
- spin = 1/2
- magnetic dipole moment:  $\mu_n = -1.9 \mu_N$ ,  $\mu_p = 2.8 \mu_N$ ,  $\mu_e \sim 10^3 \mu_n$ ,
- velocity ( $v$ ), kinetic energy ( $E$ ), temperature ( $T$ ), wavevector ( $k$ ), wavelength ( $\lambda$ )

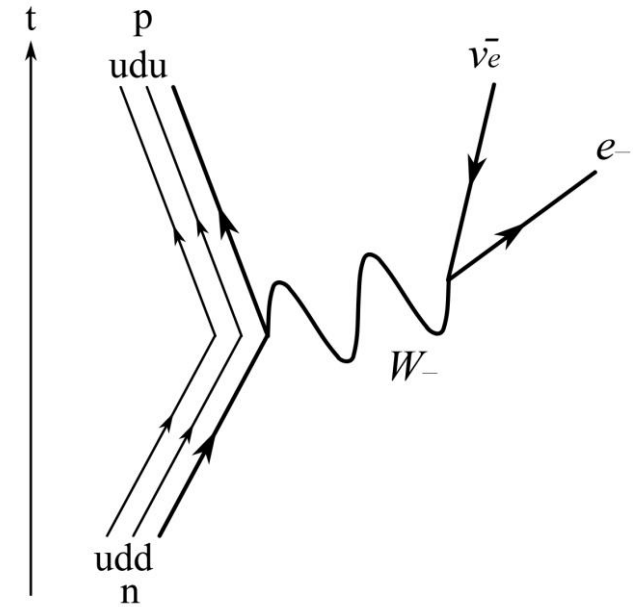



# THE NEUTRON

## As a particle

- velocity ( $v$ ), kinetic energy ( $E$ ), temperature ( $T$ ), wavevector ( $k$ ), wavelength ( $\lambda$ )

$$E = m_n v^2 / 2 = k_B T = (h k / 2\pi)^2 / 2m_n = (h/\lambda)^2 / 2m_n$$

- Neutron energy determines velocity and therefore time-of-flight ( $tof$ ) over a given distance i.e.  $tof \rightarrow$  energy determination

$$tof = \frac{L}{v} = 253 \mu\text{sec} \cdot \lambda \left[ \overset{\circ}{\text{A}} \right] \cdot L [m]$$

# THE NEUTRON

As a probe

	Energy	Temperature (K)	Wavelength (nm)	velocity (m/s)
Ultra cold neutrons	$< 10 \mu\text{eV}$	$< 0.05$	$> 30$	$< 15$
Cold neutrons	100 - 5000 $\mu\text{eV}$	1 - 60	0.4 - 3	150 - 1000
Thermal neutrons	5 - 50 meV	60 - 600	0.13 - 0.4	1000 - 4000
Hot neutrons	0.05 - 0.5 eV	600 - 6000	0.04 - 0.13	4000 - 10000

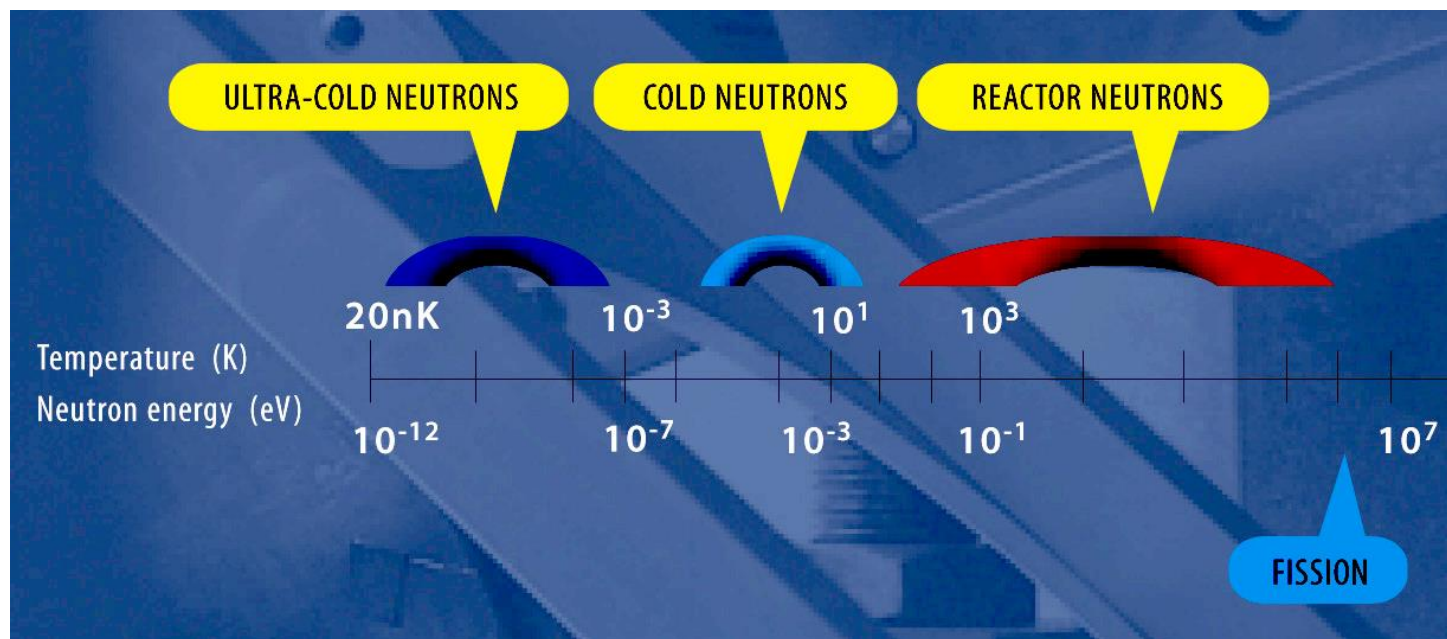





# THE NEUTRON

## As a probe

- Wavelengths on the scale of inter-atomic distances:  
 $\text{\AA} - nm$  wavelengths to measure  $\text{\AA} - \mu m$   
distances/sizes

$$n\lambda = 2d\sin\theta$$

- Energies comparable to structural and magnetic excitations:  $meV$  neutrons to measure  $neV - meV$  energies
- Neutral particle – gentle probe, highly penetrating (e.g. 30 cm of Al), no radiation damage (low flux & energy)
- Magnetic moment (nuclear spin) probes magnetism of unpaired electrons (N.B.  $\mu_e \sim 1000 \times \mu_N$ )

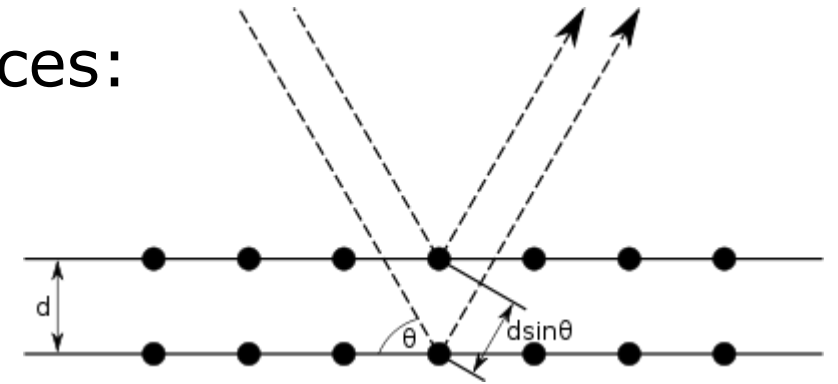



# THE NEUTRON

As a probe – interacting with matter – scattering from atoms

- Neutron flux at reactor core
- $1.5 \times 10^{15}$  n/cm<sup>2</sup>/s
- Flux at an instrument sample position
- $10^8$  n/cm<sup>2</sup>/s
- $10^{-6}$  n/μm<sup>2</sup>/μs
- $10^{-15}$  n/nm<sup>2</sup>/ns
- On these time and length scales, neutrons are being scattered one at a time
- Need wave-particle duality of neutrons

interference pattern  
in front of detector

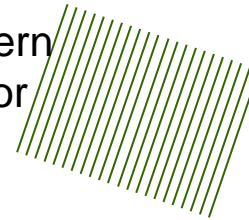

spherical waves  
emitted by  
scattering centres

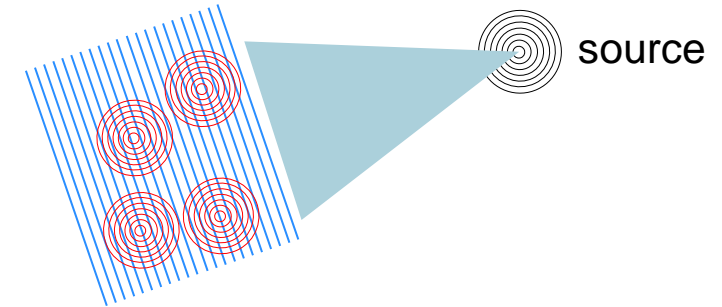

plane waves in  
scattering system

# THE NEUTRON

As a probe – interacting with matter – (elastic) scattering from a single fixed nucleus

- Nuclear size  $\ll$  neutron wavelength  $\rightarrow$  point-like s-wave scattering
- $b$  is the scattering length ('power') in  $fm$
- # neutrons scattered per second per unit solid angle  $\Omega$ :  $\Psi^2 r^2 d\Omega$   

$$d\sigma/d\Omega = b^2$$
- $\sigma$  is the cross-section:  $4\pi b^2$  (in barns –  $100 \text{ fm}^2$ )

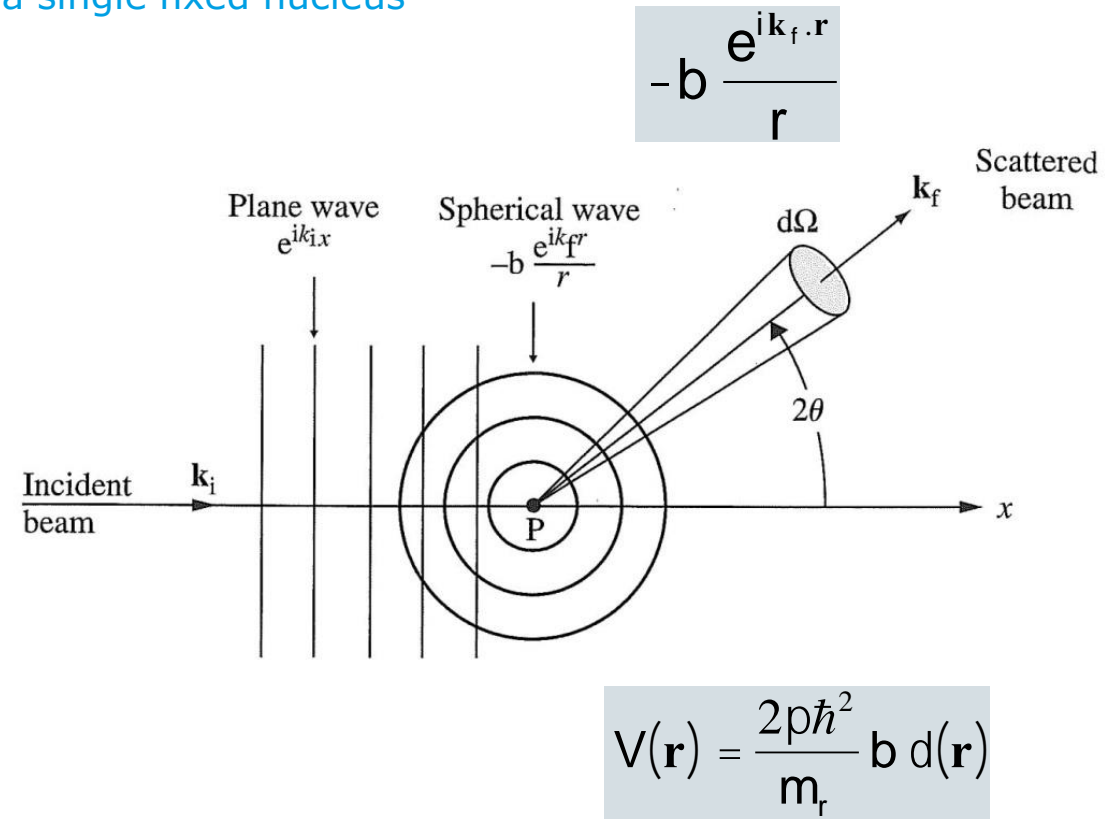



# THE NEUTRON

As a probe – interacting with matter – scattering from a set of nuclei

$$\frac{d\sigma}{d\Omega} = \sum_{j,k} b_j b_k e^{i\vec{Q} \cdot (\vec{R}_j - \vec{R}_k)}$$

$$\vec{Q} = \vec{k}_f - \vec{k}_i$$

- $Q$  is called momentum transfer
- $Q$ -dependence (e.g. angle) gives info about atomic positions

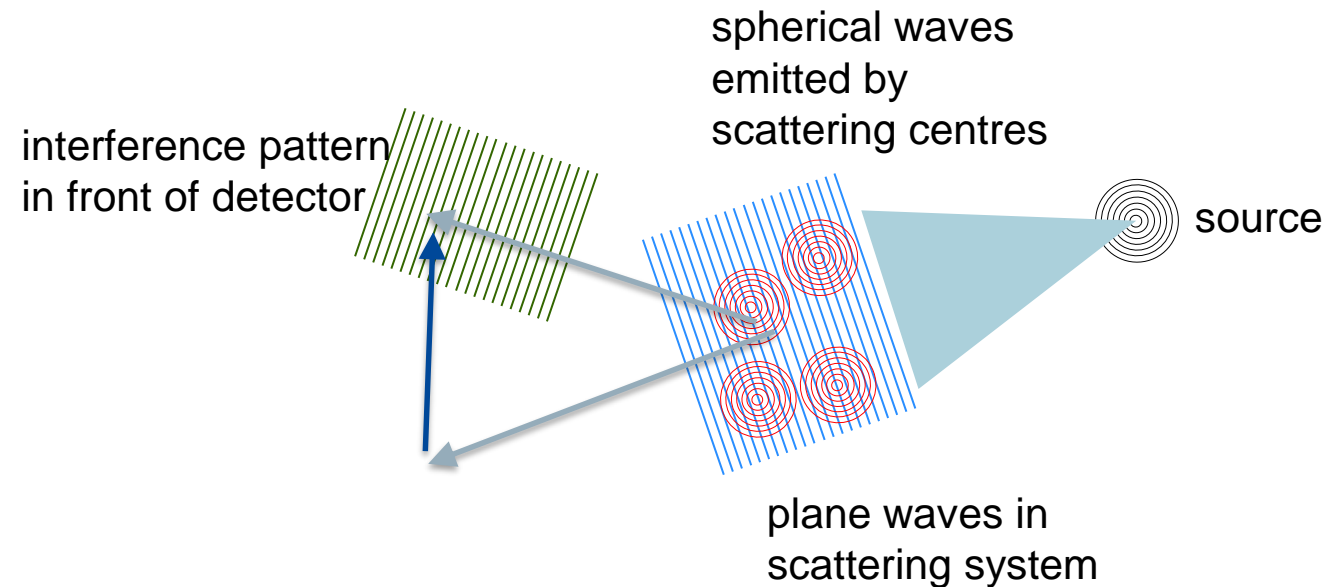

# THE NEUTRON

As a probe – interacting with matter – scattering from a set of identical nuclei – coherent and incoherent scattering

- Set of  $N$  similar atoms/ions – spins/isotopes are *uncorrelated* at different sites
- $b$  depends on spin/isotope
- Average is  $\langle b \rangle$
- Incoherent scattering gives a  $Q$  independent background
- But it can be useful to probe the dynamics of single particles (later)

$$\frac{d\sigma}{d\Omega} = \langle b \rangle^2 \sum_{j,k} e^{iQ \cdot (R_j - R_k)} + \left( \langle b^2 \rangle - \langle b \rangle^2 \right) N$$

$$\sigma_{coh} = 4\pi \langle b \rangle^2$$

$$\sigma_{incoh} = 4\pi \left( \langle b^2 \rangle - \langle b \rangle^2 \right)$$

$$\sigma_{coh} = 4\pi b_{coh}^2$$

$$\sigma_{incoh} = 4\pi b_{inc}^2$$

# THE NEUTRON

As a probe – interacting with matter – scattering from a set of identical nuclei – coherent and incoherent scattering

- If single isotope and zero nuclear spin, no incoherent scattering
- If single isotope and non-zero nuclear spin  $I$
- nucleus+neutron spin:  $I+1/2$  and  $I-1/2$  scattering length  $b^+$  and  $b^-$
- To reduce incoherent scattering (background):
  - polarise nuclei and neutrons
  - use isotope substitution e.g. H → D

$$\langle b \rangle = \frac{1}{2I+1} [(I+1)b^+ + Ib^-]$$

$$\langle b^2 \rangle - \langle b \rangle^2 = \frac{I(I+1)}{(2I+1)^2} (b^+ - b^-)^2$$



# THE NEUTRON

Scattering lengths  
Light atoms  
Contrast

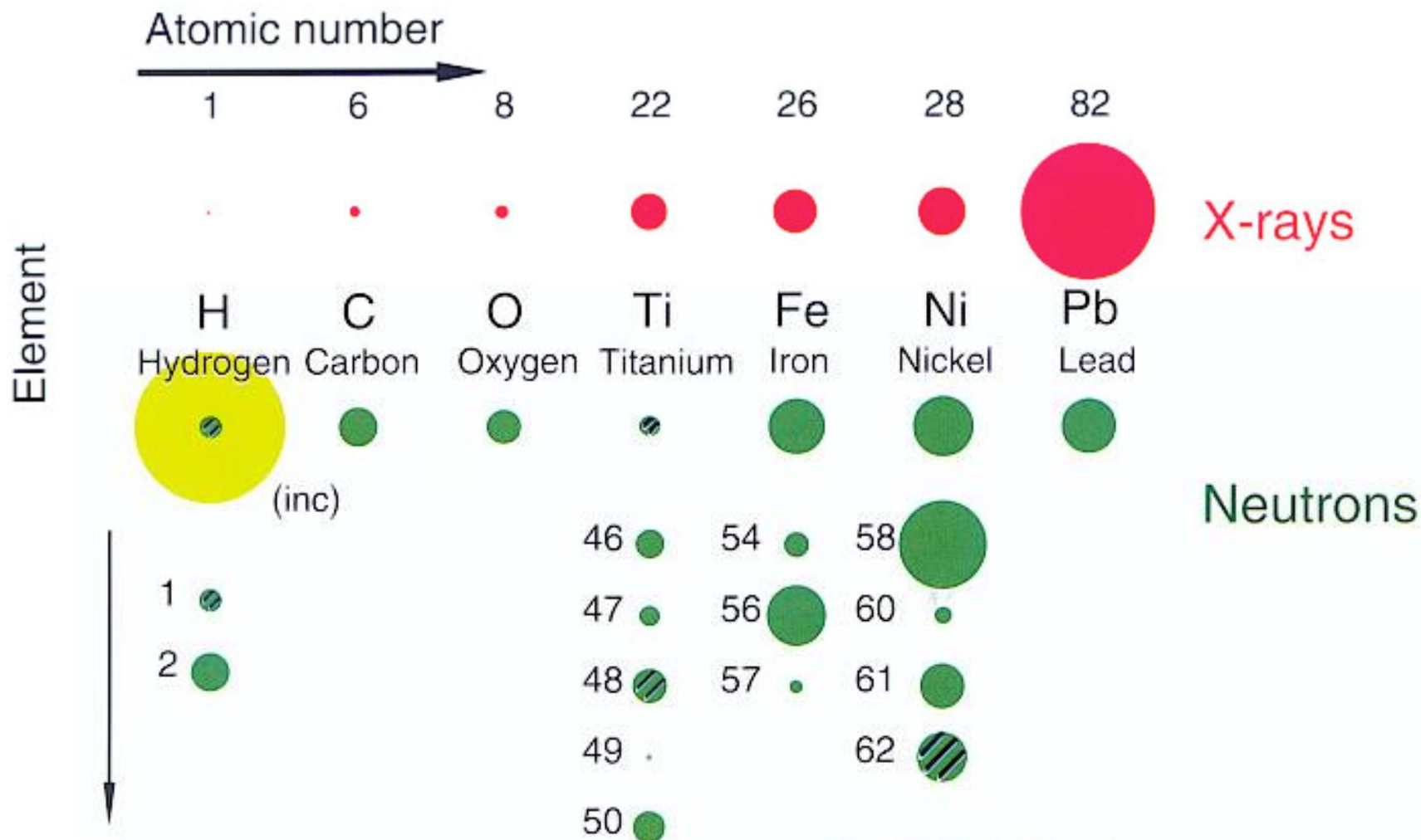

# THE NEUTRON

Scattering lengths can be positive or negative (nuclear physics)

- Positive  $b$  (most nuclei): phase change
- Negative  $b$ : no phase change at scattering point

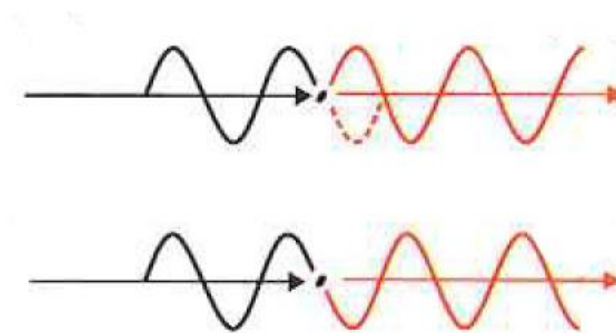

ZSymbA	p or T <sub>1/2</sub>	I	b <sub>c</sub>	b <sub>+</sub>	b <sub>-</sub>	c	σ <sub>coh</sub>	σ <sub>inc</sub>	σ <sub>scatt</sub>	σ <sub>abs</sub>
0-N-1	10.3 MIN	1/2	-37.0(6)	0	-37.0(6)		43.01(2)		43.01(2)	0
1-H			-3.7409(11)				1.7568(10)	80.26(6)	82.02(6)	0.3326(7)
1-H-1	99.985	1/2	-3.7423(12)	10.817(5)	-47.420(14)	+/-	1.7583(10)	80.27(6)	82.03(6)	0.3326(7)
1-H-2	0.0149	1	6.674(6)	9.53(3)	0.975(60)		5.592(7)	2.05(3)	7.64(3)	0.000519(7)
1-H-3	12.26 Y	1/2	4.792(27)	4.18(15)	6.56(37)		2.89(3)	0.14(4)	3.03(5)	< 6.0E-6
2-He			3.26(3)				1.34(2)	0	1.34(2)	0.00747(1)
2-He-3	0.00013	1/2	5.74(7)	4.374(70)	9.835(77)	E	4.42(10)	1.532(20)	6.0(4)	5333.0(7.0)
2-He-4	0.99987	0	3.26(3)				1.34(2)	0	1.34(2)	0
3-Li			-1.90(3)				0.454(10)	0.92(3)	1.37(3)	70.5(3)
3-Li-6	7.5	1	2.0(1)	0.67(14)	4.67(17)	+/-	0.51(5)	0.46(5)	0.97(7)	940.0(4.0)
3-Li-7	92.5	3/2	-2.22(2)	-4.15(6)	1.00(8)	+/-	0.619(11)	0.78(3)	1.40(3)	0.0454(3)

# THE NEUTRON

Scattering lengths can be positive or negative  
→ Contrast matching

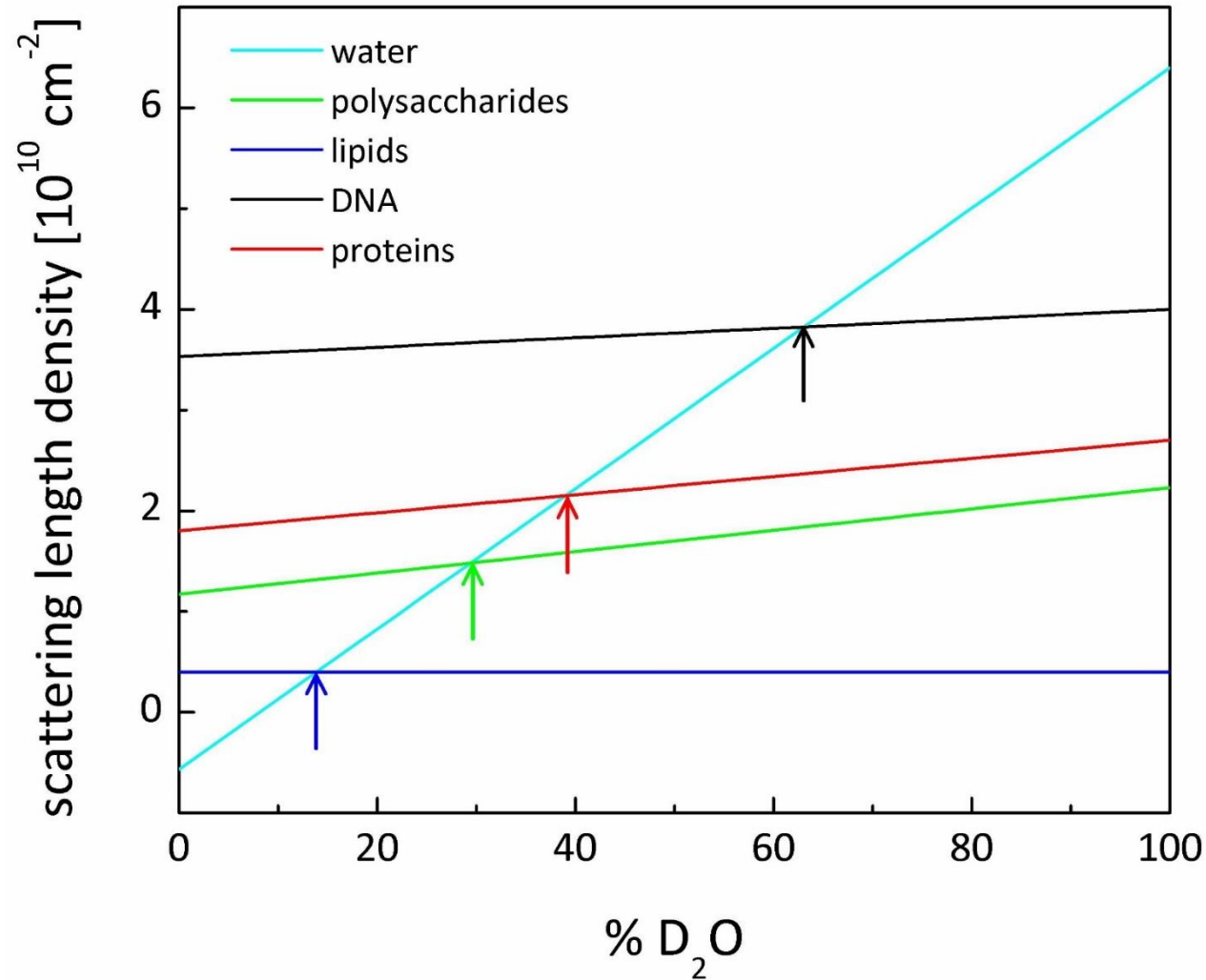
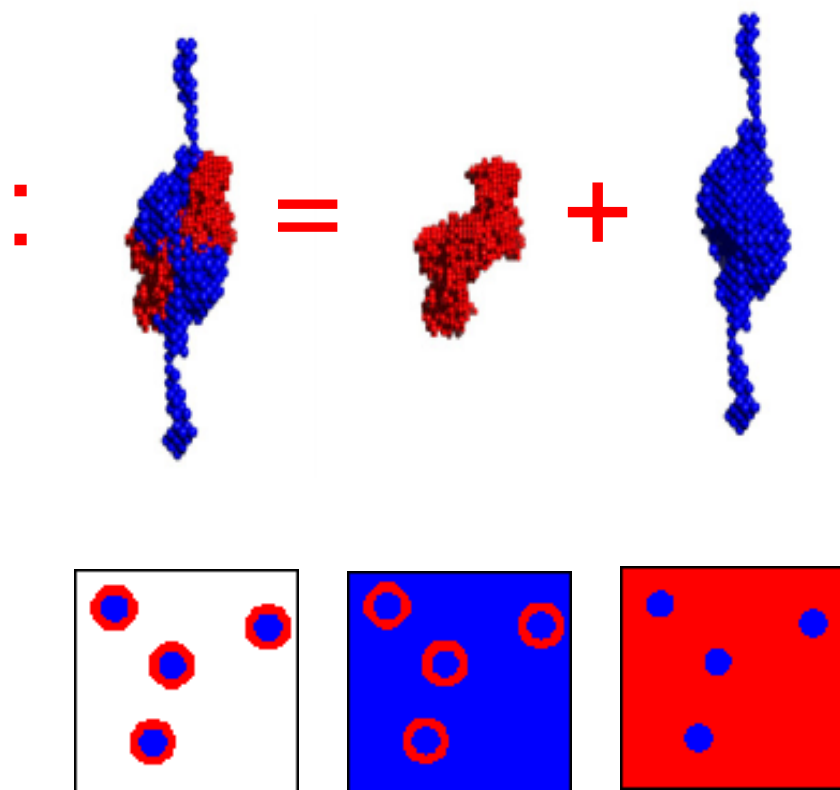



# THE NEUTRON

As a probe – interacting with matter - absorption

- Absorption – neutron capture
- Several strong absorbers:  
He, Li, B, Cd, Gd,...
- Isotope dependent – choose to your advantage

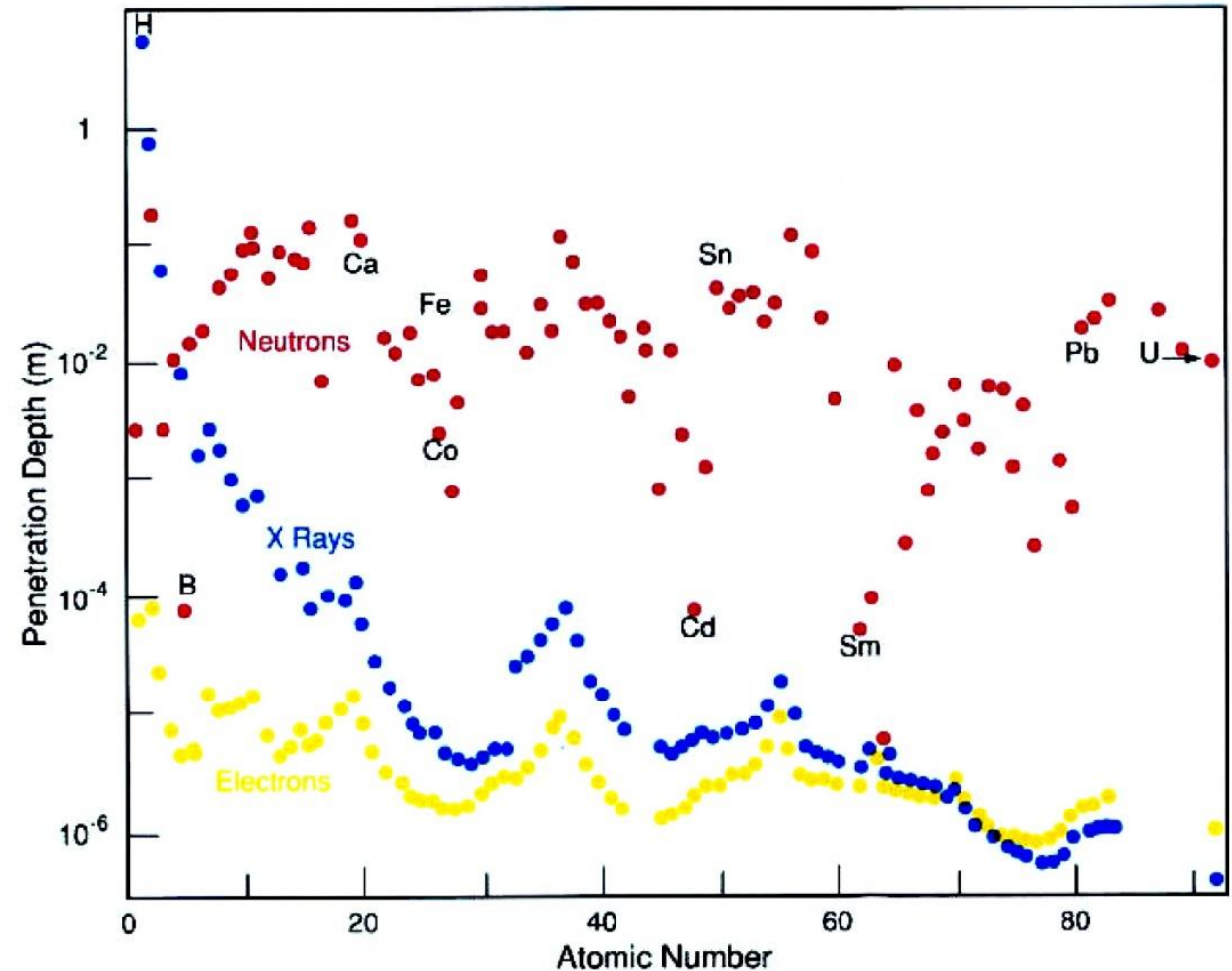

# THE NEUTRON

As a probe – interacting with matter - absorption - Neutron detection

- How to detect a weakly interacting, neutral particle?
- With a neutron absorber and measure the resulting signal

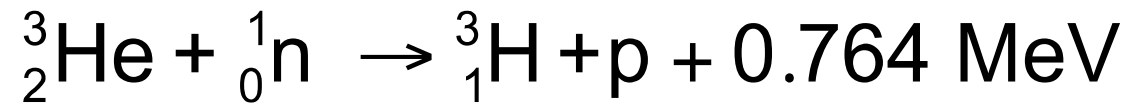

# THE NEUTRON



Scattering and absorption cause attenuation of a neutron beam → imaging

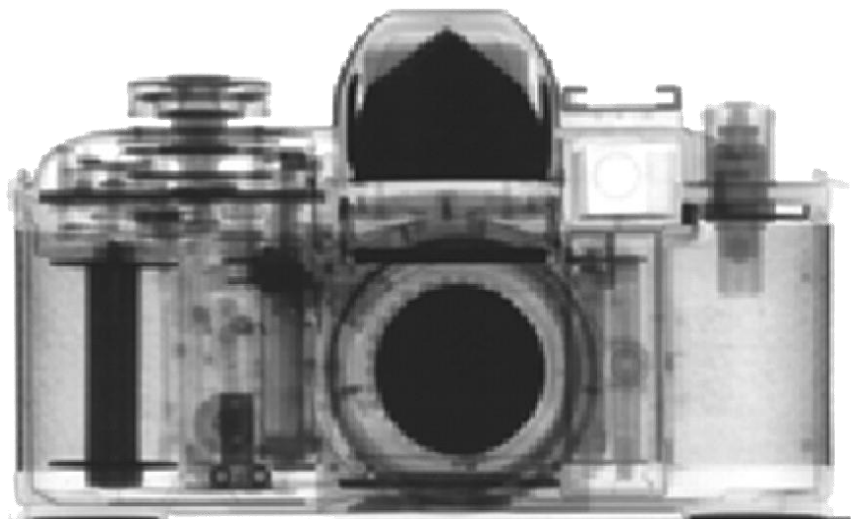

NEUTRONS



X-RAYS



# THE NEUTRON

Imaging Li-ion batteries - NATURE COMM | <https://doi.org/10.1038/s41467-019-13943-3>

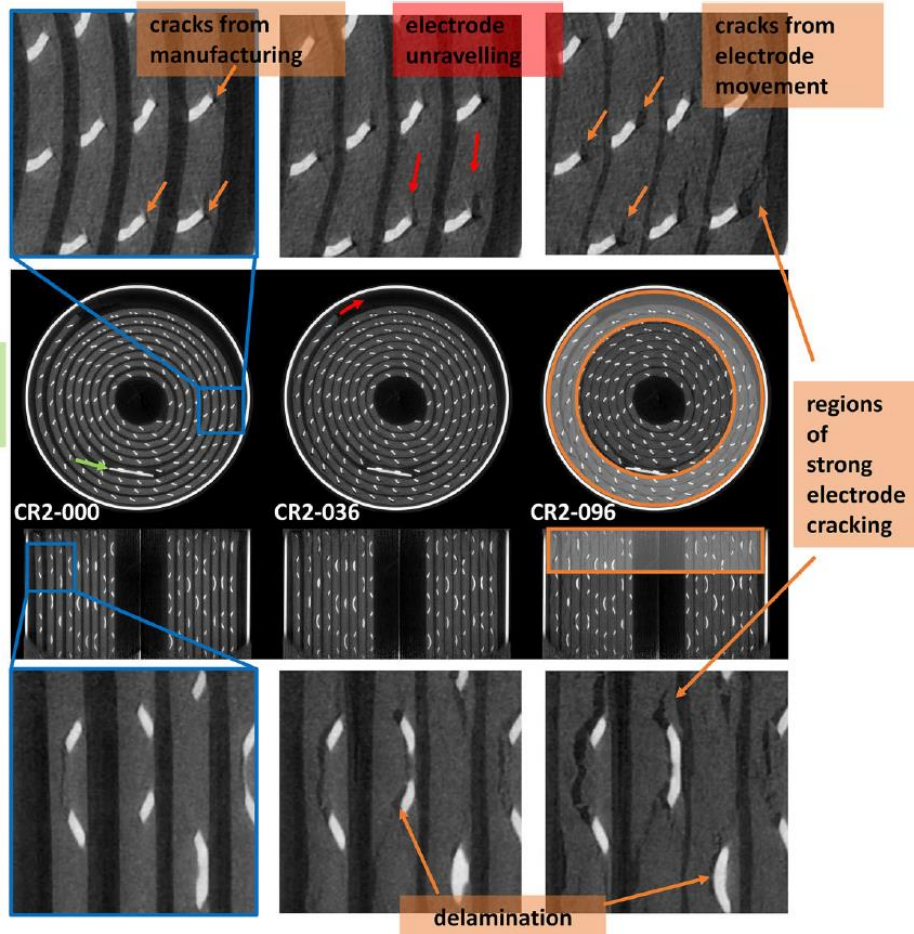

b

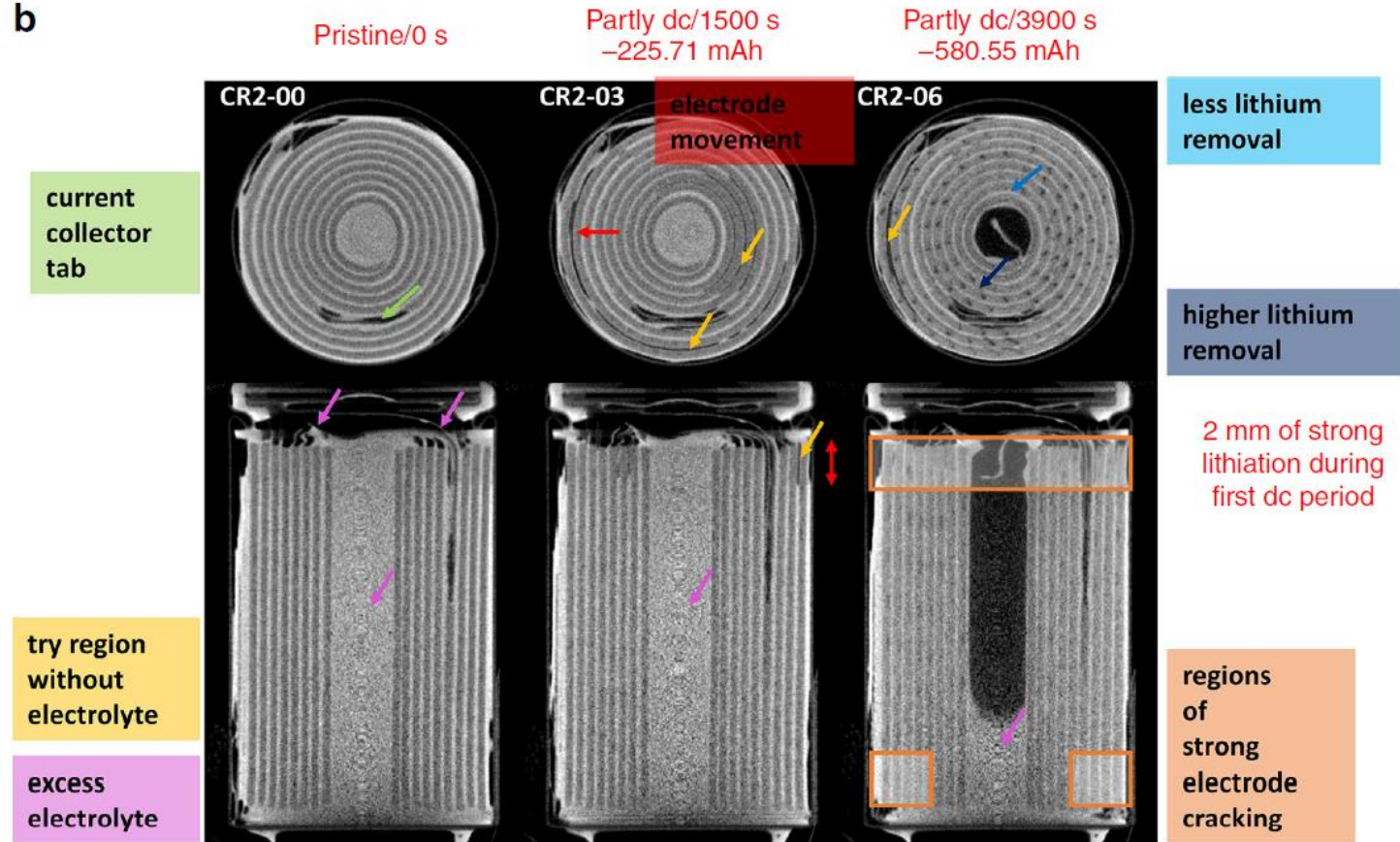

# THE NEUTRON

As a probe – interacting with matter - summary

- Interaction with nuclei:
  - short range interaction → angle independent scattering (no form factor)
  - scattering length can be positive or negative (→ contrast variation)
  - depends on isotope (→ selectivity) and nuclear spin
  - Coherent and incoherent scattering – strength and weakness
  - Scattering contrast different from X-rays, favours light atoms
- A gentle probe – low intensity, meV neutron beam does not cause radiation damage like a  $\sim 10$  keV photon beam (what about XFEL!)
- Magnetic moment probes magnetism of unpaired electrons

# NEUTRONS AND THEIR INTERACTION WITH MATTER

## Overview

- History – neutrons and nuclear reactions
- Production – reactors and spallation sources
  - Properties – as a particle and a probe
- *Instruments – exploiting the probe to do science*



# INSTRUMENTS & SCIENCE

Time and length scales

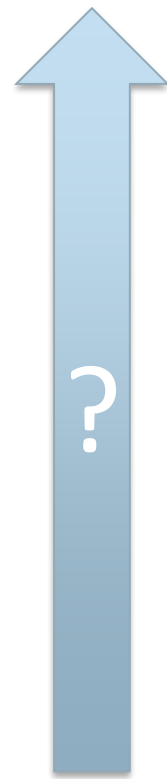
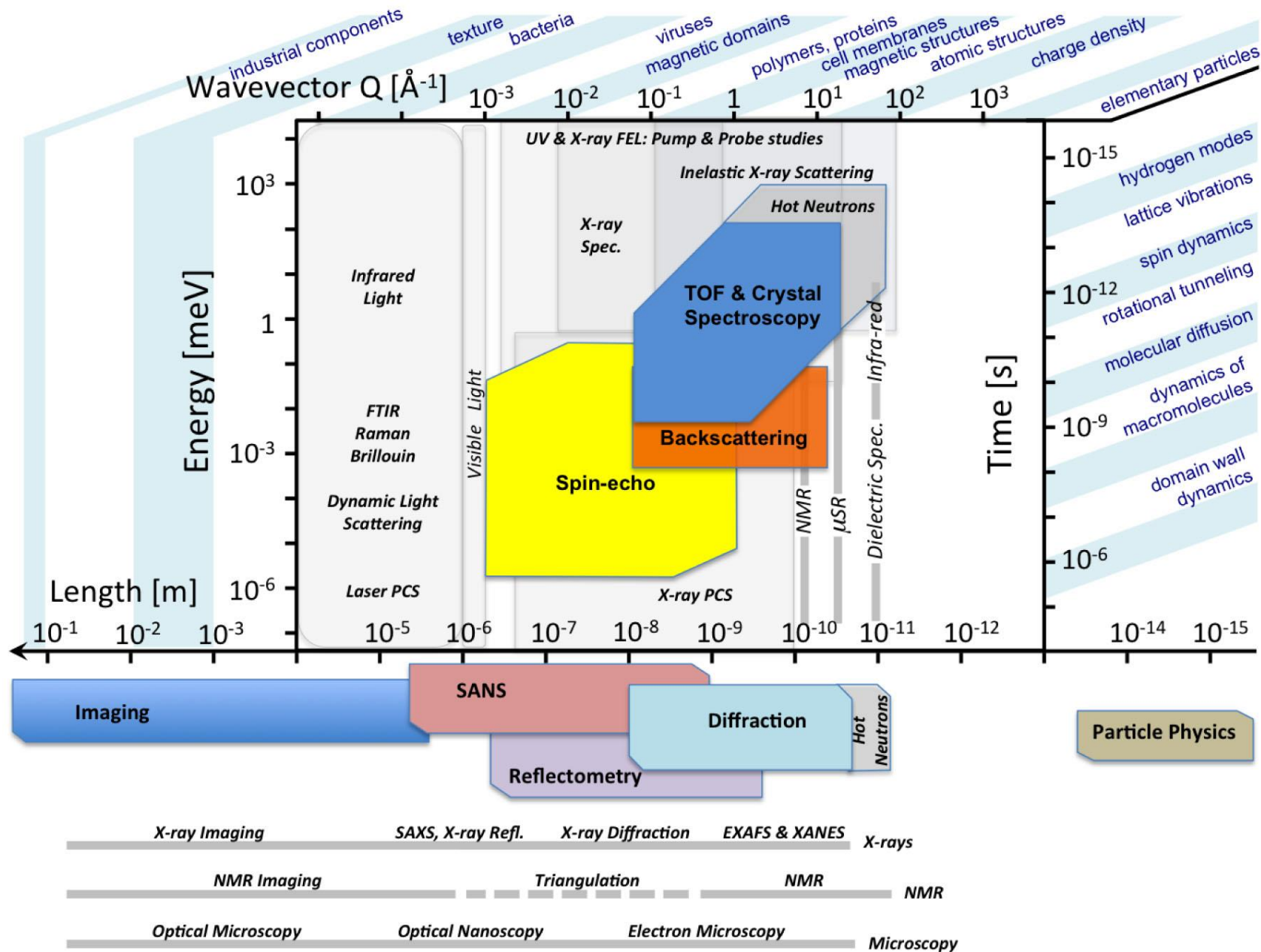

# THE ILL'S INSTRUMENT SUITE

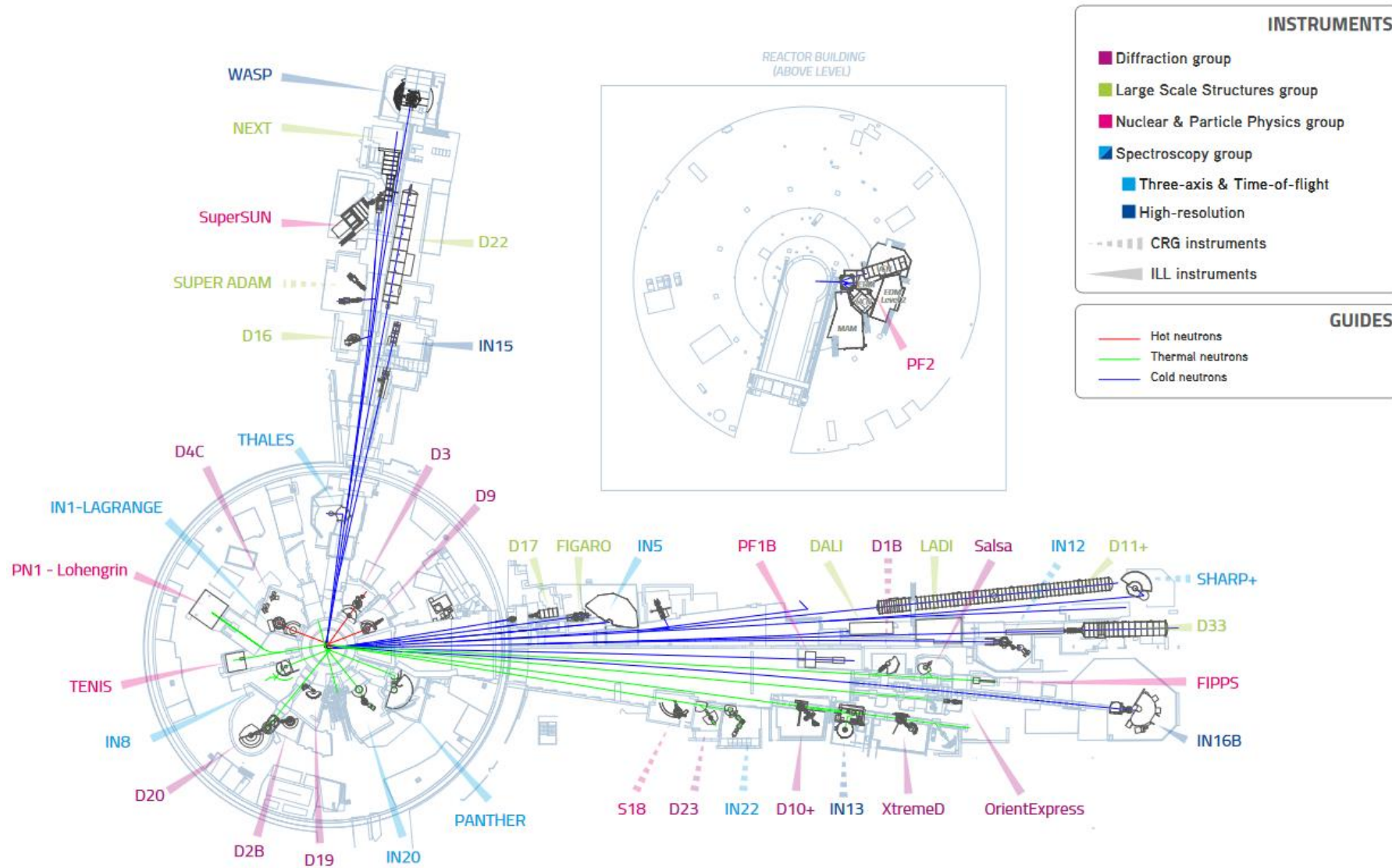

# GENERAL EXPRESSION FOR SCATTERING FROM A COMPLEX SYSTEM

Deriving the general scattering function

Based on

- Born approximation – kinematic theory: neutron wavefunction un-perturbed inside sample
- Fermi's Golden Rule to calculate transitions of neutron ( $k$ ) and system ( $\lambda$ ) from initial and final state
- Hamiltonian to describe the system states ( $\lambda$ )

$$\frac{d\sigma}{d\Omega} = \frac{\sum_{k_f \text{ in } d\Omega} W_{k_i, \lambda_i \rightarrow k_f, \lambda_f}}{\Phi \, d\Omega}$$

$$\sum_{k_f \text{ in } d\Omega} W_{k_i, \lambda_i \rightarrow k_f, \lambda_f} = \frac{2\pi}{\hbar} \rho_{k_f} |\langle \mathbf{k}_f \lambda_f | V | \mathbf{k}_i \lambda_i \rangle|^2$$

$$\left( \frac{d^2\sigma}{dE_f d\Omega} \right)_{\lambda_i \rightarrow \lambda_f} = \frac{k_f}{k_i} \left( \frac{m_n}{2\pi\hbar^2} \right)^2 |\langle \mathbf{k}_f \lambda_f | V | \mathbf{k}_i \lambda_i \rangle|^2 \delta(E_i - E_f + E_{\lambda_i} - E_{\lambda_f})$$



# GENERAL EXPRESSIONS FOR SCATTERING FROM A SET OF MOVING ATOMS

Deriving the scattering function – end up with (after much algebra and manipulations!)

$$\left( \frac{d^2\sigma}{dEd\Omega} \right) = \frac{k_f}{k_i} \frac{1}{2\pi\hbar} \sum_{jk} b_j b_k \int_{-\infty}^{+\infty} \left\langle \exp\left\{ -i\vec{Q} \cdot \vec{R}_j(0) \right\} \exp\left\{ i\vec{Q} \cdot \vec{R}_k(t) \right\} \right\rangle \exp(i\omega t) dt$$

$$\left( \frac{d^2\sigma}{dEd\Omega} \right) = \frac{k_f}{k_i} \frac{1}{2\pi\hbar} S(\vec{Q}, \omega)$$

- Experiment measures double differential cross-section which is simply related to  $S(Q, \omega)$  (or  $I(Q, t)$ )
- $S(Q, \omega)$  is the double Fourier transform of the time-dependent pair-correlation function

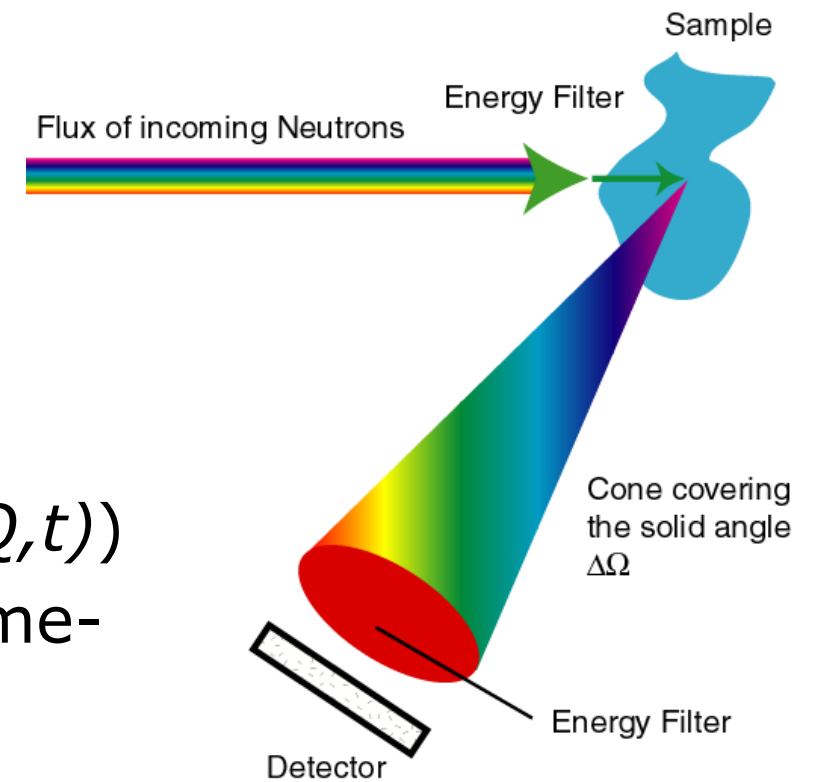

# GENERAL EXPRESSIONS FOR SCATTERING FROM A SET OF MOVING ATOMS

Deriving the scattering function – end up with coherent & incoherent contributions

- For a simple system with a single element but different  $b$ 's

$$\left. \frac{d^2\sigma}{d\Omega dE_f} \right)_{coh} = \frac{\sigma_{coh} k_f}{4\pi k_i} \frac{1}{2\pi\hbar} \sum_{jk} \int_{-\infty}^{+\infty} \left\langle \exp\left\{-i\vec{Q}\cdot\vec{R}_j(0)\right\} \exp\left\{i\vec{Q}\cdot\vec{R}_k(t)\right\} \right\rangle \exp(-i\omega t) dt$$

$$\left. \frac{d^2\sigma}{d\Omega dE_f} \right)_{incoh} = \frac{\sigma_{incoh} k_f}{4\pi k_i} \frac{1}{2\pi\hbar} \sum_j \int_{-\infty}^{+\infty} \left\langle \exp\left\{-i\vec{Q}\cdot\vec{R}_j(0)\right\} \exp\left\{i\vec{Q}\cdot\vec{R}_j(t)\right\} \right\rangle \exp(-i\omega t) dt$$

- Scattering function determined by positions  $R$  of different atoms at different times  $t$
- Incoherent scattering can be useful: it measures the correlation between the same atom at different times  $\rightarrow$  single particle dynamics  
- diffusion

# GENERAL SCATTERING EXPERIMENT

## Scattering triangle – handling $Q$ and $\omega$

- $\mathbf{Q} = \mathbf{k}_f - \mathbf{k}_i$ ,  $\hbar\omega = E_f - E_i$  ( $E \sim k^2$ ,  $k = 2\pi/\lambda$ )
- Elastic scattering:
  - vary  $Q$  without changing  $\omega$
  - $E_i = E_f$  vary  $2\Theta$  (*monochromatic*)
  - vary  $|E|$  fix  $2\Theta$  (*t.o.f.*)
- Quasi/in-elastic scattering:
  - vary  $\omega$ , normally  $Q$  will also change
  - vary  $E_i$  or  $E_f$  and/or  $2\Theta$

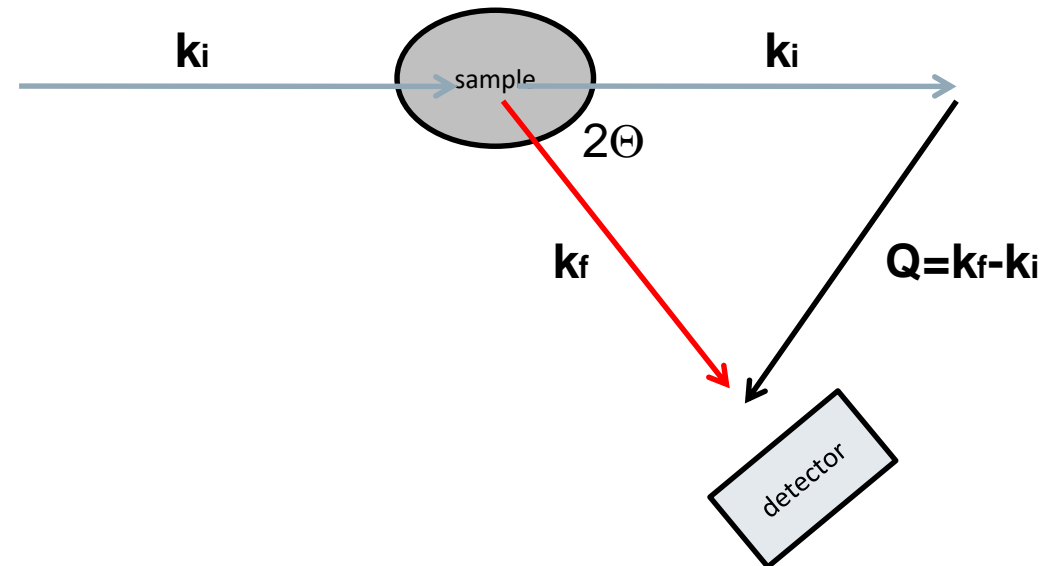



# GENERIC INSTRUMENT

## Energy selection

- How to measure the energy of a neutron beam?
- Or, how to monochromate a beam?
- Measure  $\lambda$  with Bragg reflection

$$n\lambda = 2d\sin\Theta$$

$d$  = distance between scattering planes

- Use neutron *t.o.f.* (or precession of neutron magnetic moments in a magnetic field)

$$tof = \frac{L}{v} = 253\mu\text{sec} \cdot \lambda \left[ \overset{\circ}{\text{\AA}} \right] \cdot L[m]$$



# DIFFRACTION

Instruments (don't measure the final energy!) – D2b & LADI

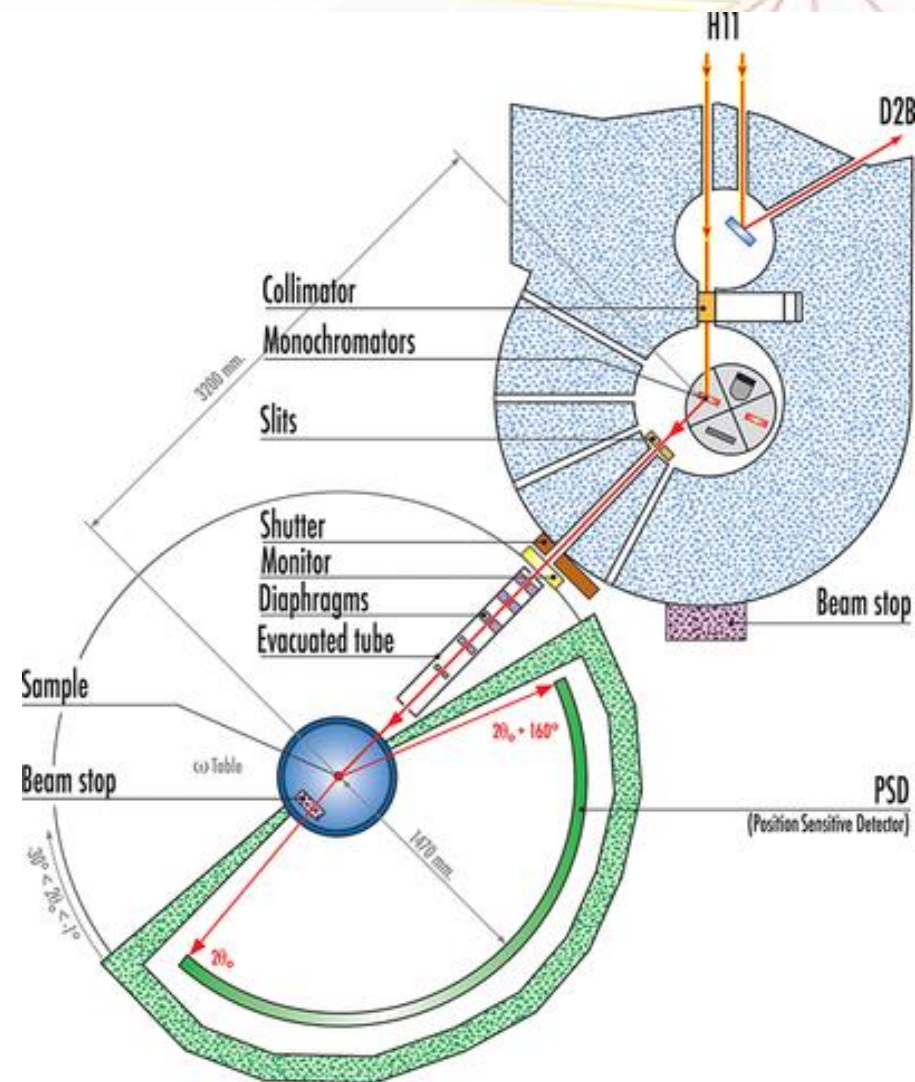
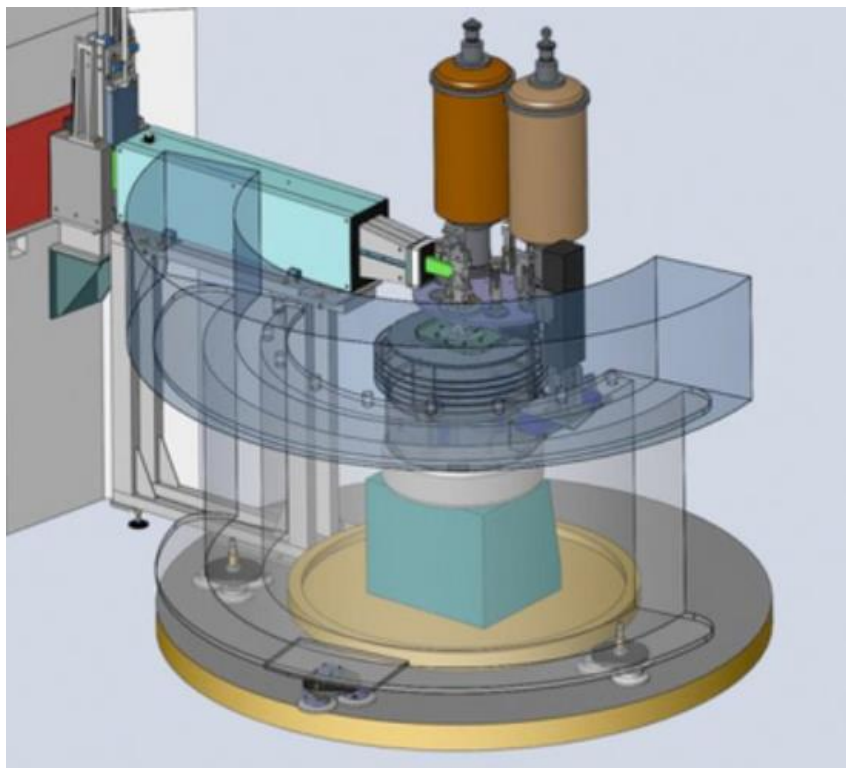

# DIFFRACTION

**Example** – Formation and properties of ice XVI obtained by emptying a type sII clathrate hydrate

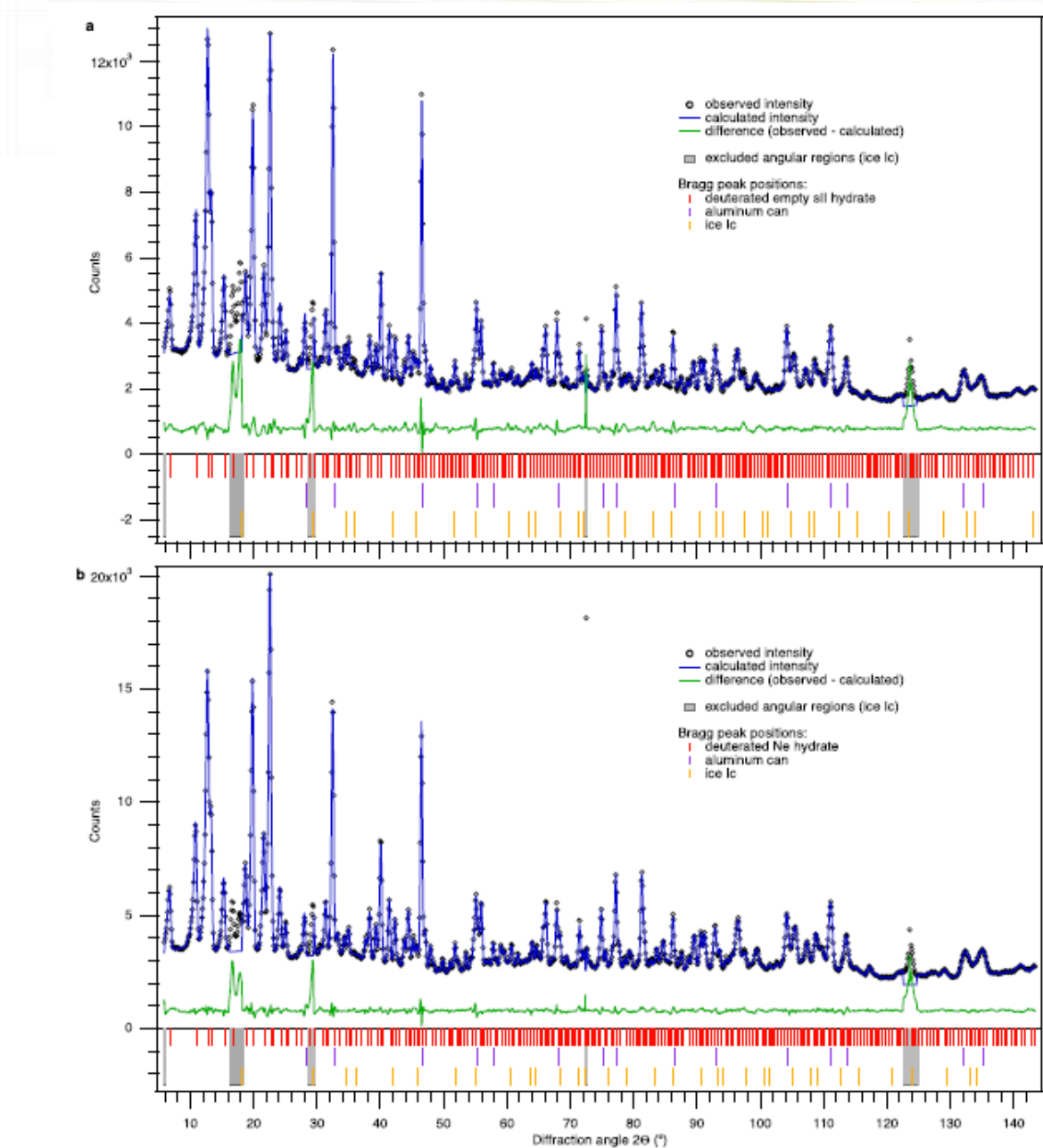
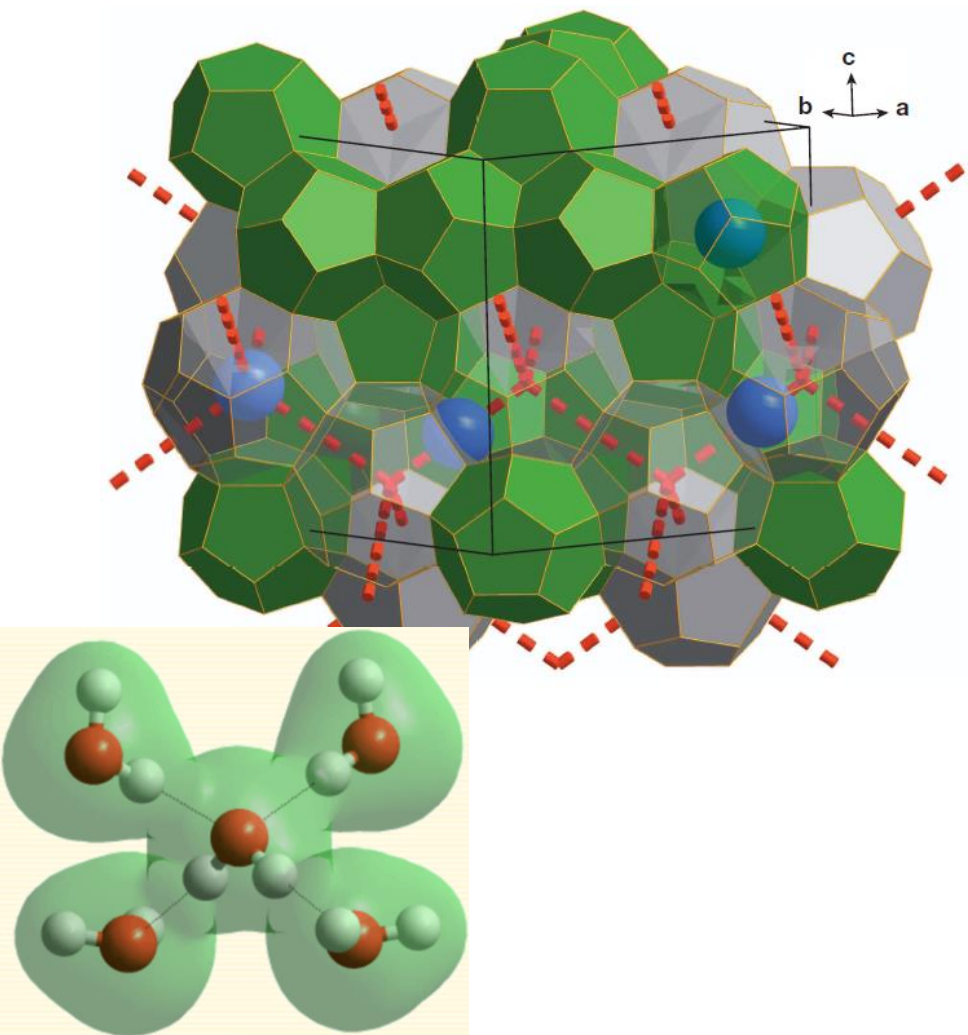

**Extended Data Figure 2 | Diffraction patterns of Ne-filled and empty hydrate.** a, b, Rietveld fit (obtained using FullProf software<sup>®</sup>) to diffraction pattern of empty sII D<sub>2</sub>O hydrate (a) and Ne D<sub>2</sub>O hydrate (b) taken at 5 K ( $\lambda \approx 1.1226 \text{ \AA}$ ) on D20, ILL/Grenoble. The observed intensity is represented by

open black circles, the calculated intensity as a blue line, the difference of both by a green line, grey shading marks the angular regions excluded in the refinement, red lines mark the positions of Bragg peaks of the hydrate, violet lines those of the aluminium sample can and orange lines those of ice Ic.



# DIFFRACTION



Instruments (don't measure the final energy!) – D2b & LADI

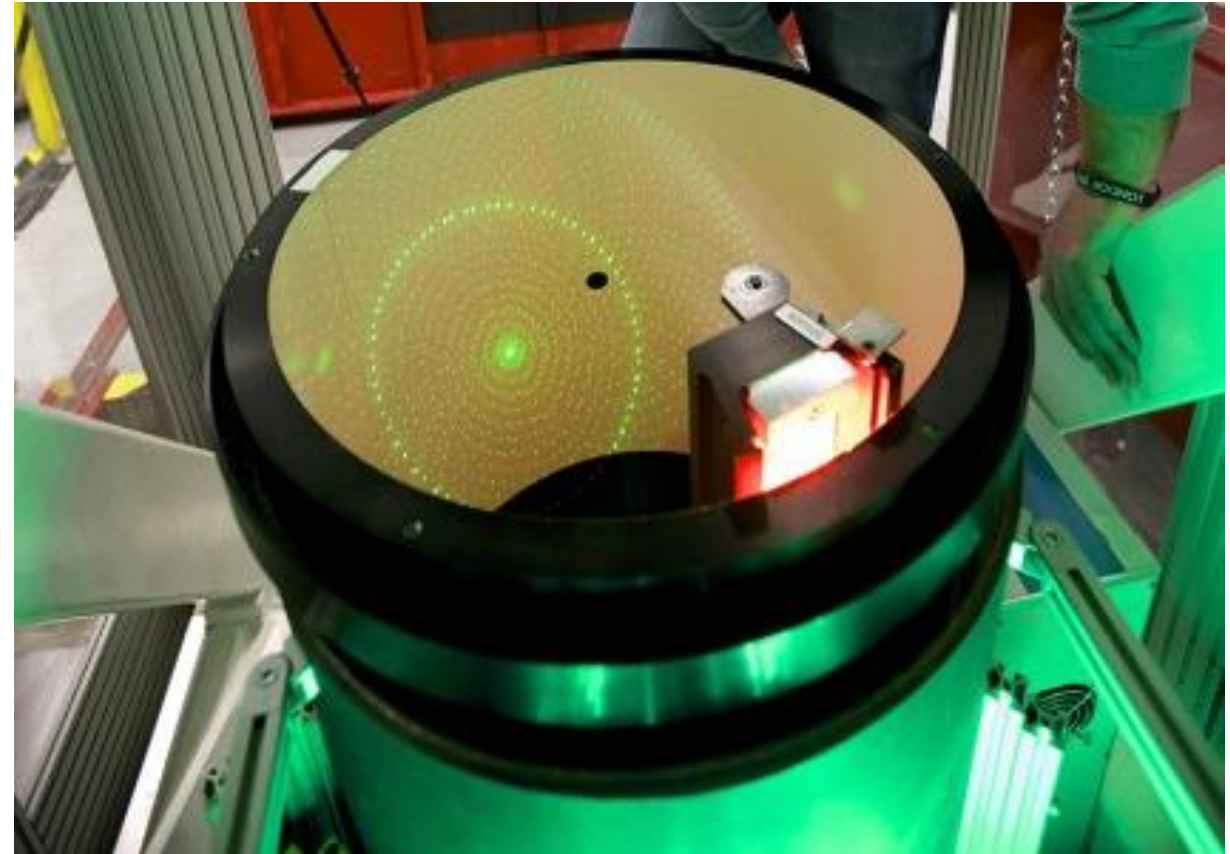
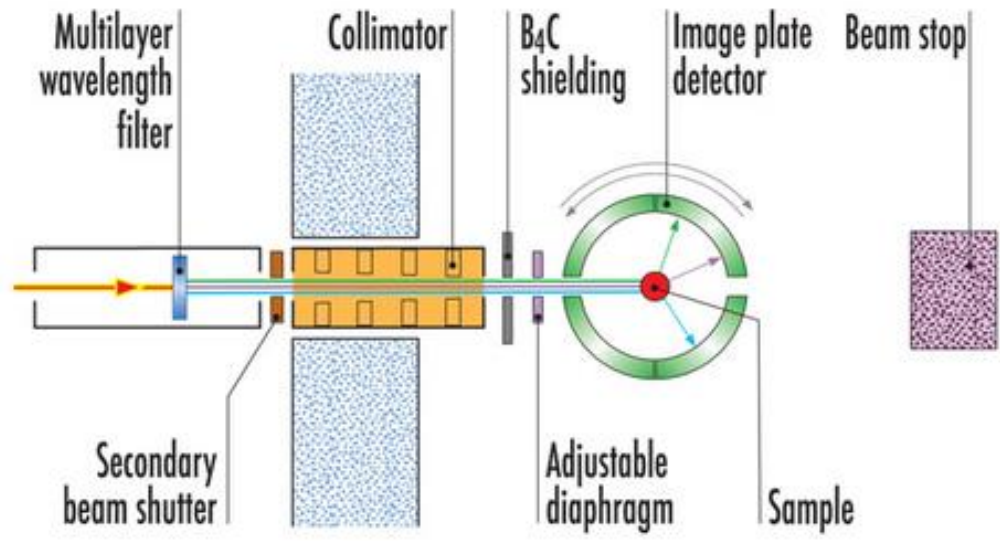

# DIFFRACTION

**Example** – Improving drug design: SARS-COV2 Main Protease in complex with new clinical inhibitors (sample ~50  $\mu\text{g}$ )

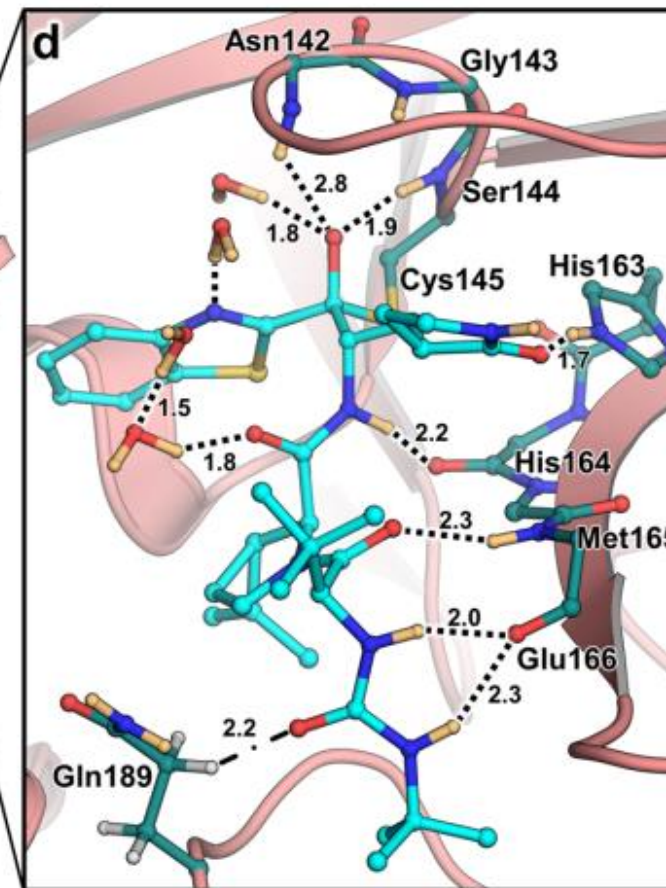
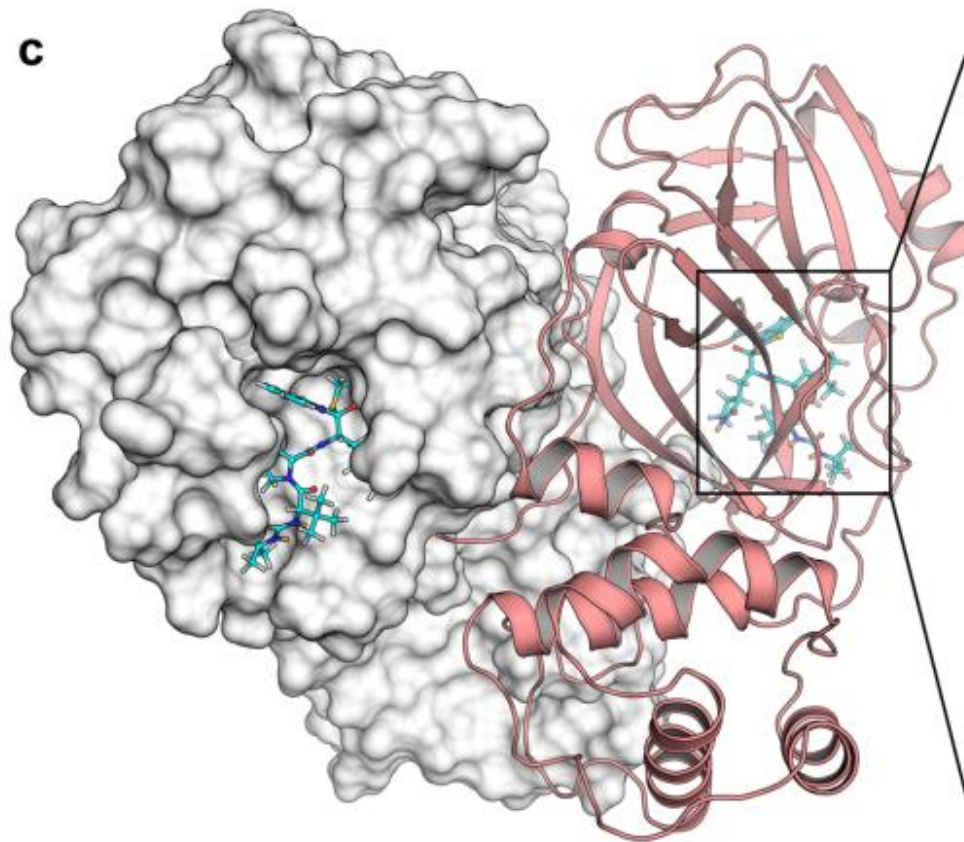
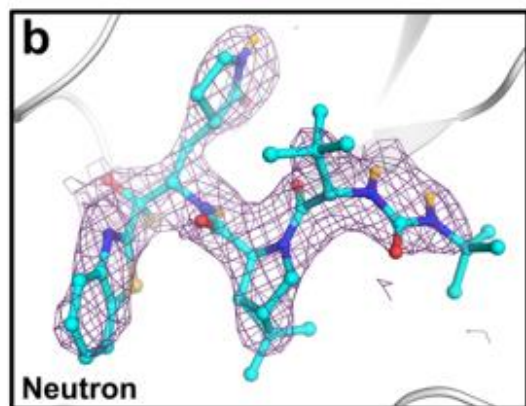
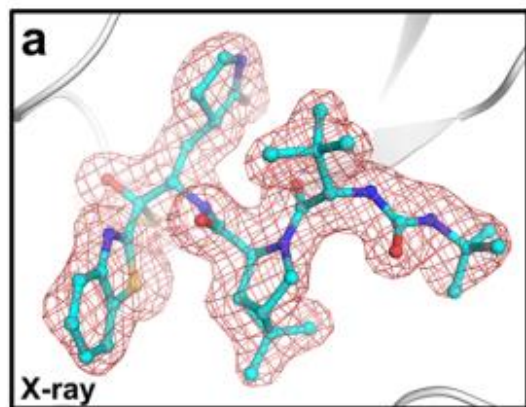



# SPECTROSCOPY – TIME/FREQUENCY DOMAIN

Simplified expressions for the scattering function – **coherent scattering**

In previous scattering expressions

$$R = R_0 + \delta R(t)$$

For normal modes:  $\delta R(t) \rightarrow$  displacement vectors  $\mathbf{e}$  & frequencies  $\omega$

Coherent scattering - Phonons:

- Short range coupling gives long range correlations
- Dispersion as a function of  $\mathbf{q}$  (or wavelength) – guitar string!

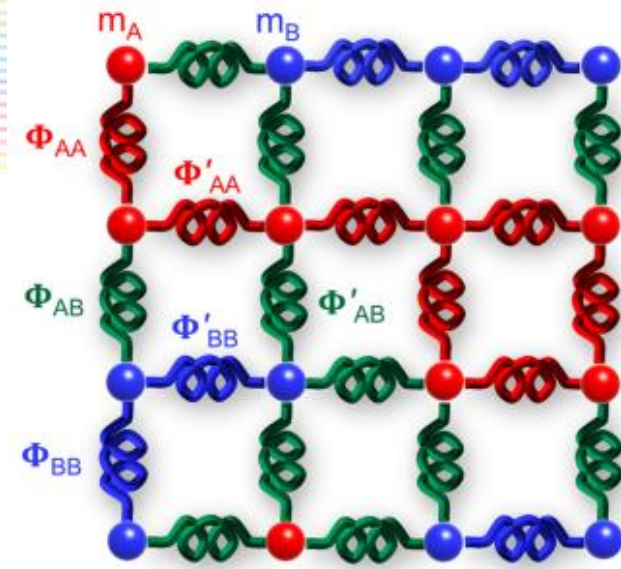

$$\left. \frac{d^2\sigma}{d\Omega dE_f} \right)_{coh\pm 1} = \frac{\sigma_{coh}}{4\pi} \frac{k_f}{k_i} \frac{(2\pi)^3}{v_0} \frac{1}{2M} \exp(-2W) \sum_s \sum_{\tau} \frac{\left( \vec{Q} \cdot \vec{e}_s \right)}{\omega_s} \langle n_s + 1/2 \pm 1/2 \rangle$$

$$\times \delta(\omega \mp \omega_s) \delta\left( \vec{Q} \mp \vec{q} - \vec{\tau} \right)$$



# SPECTROSCOPY – TIME/FREQUENCY DOMAIN

Instruments – varying  $k_i$  &  $k_f$  – TAS, TOF

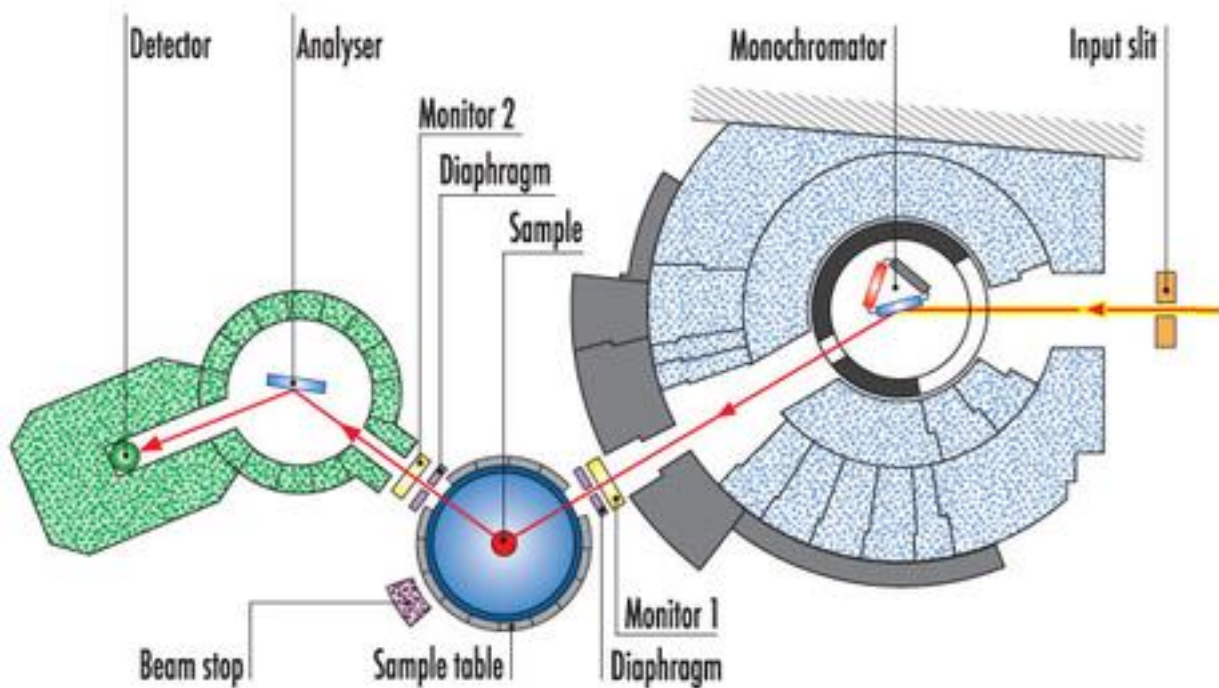

# SPECTROSCOPY – TIME/FREQUENCY DOMAIN

**Example** – heat gradient (low thermal conductivity – short phonon paths and lifetimes) generates current in thermoelectrics - Complex Metallic Alloy -  $\text{Al}_{13}\text{Co}_4$  Quasicrystal approximant

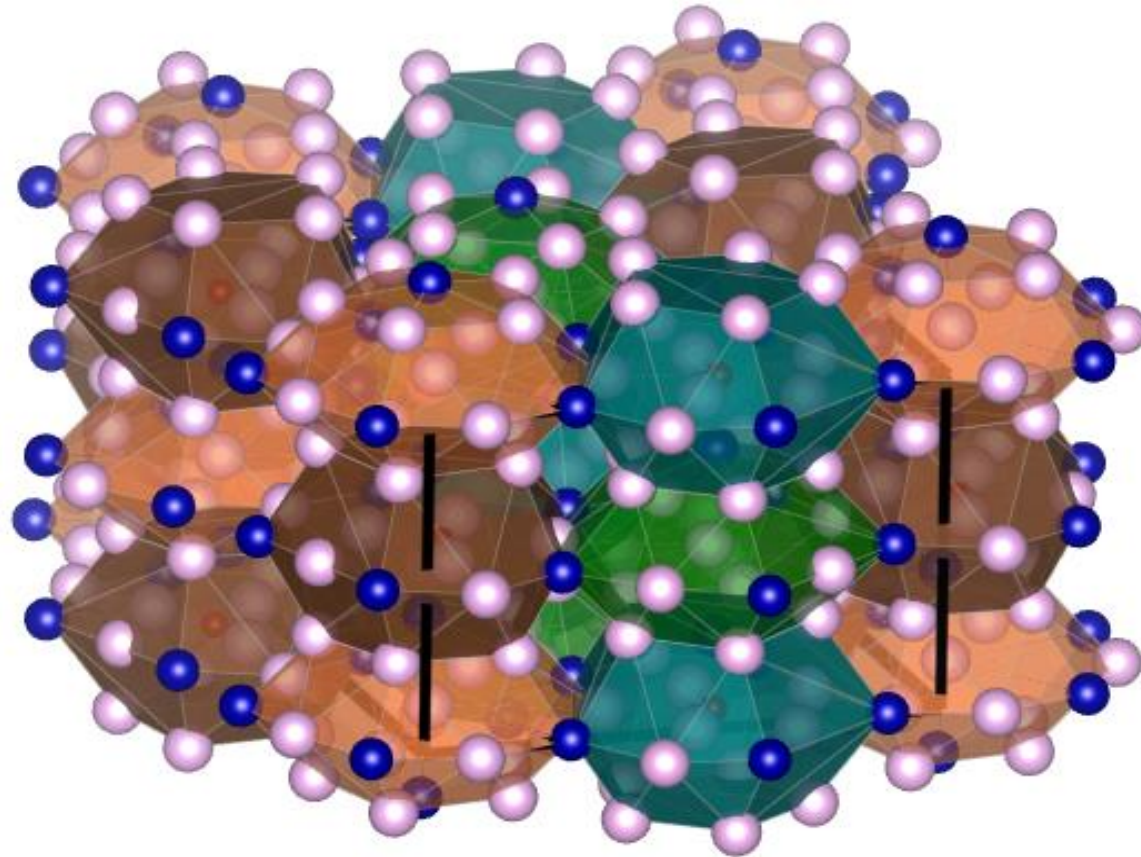
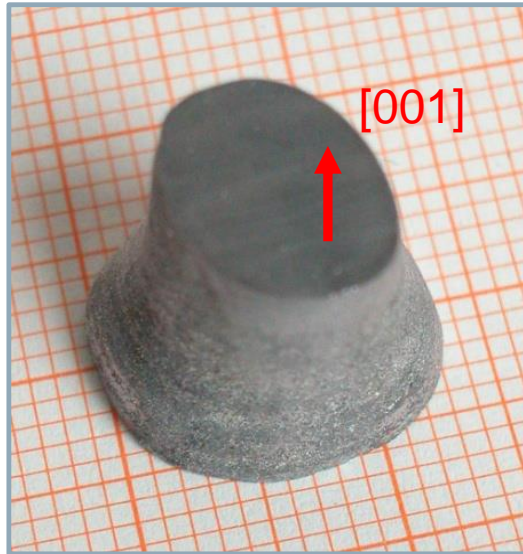



# SPECTROSCOPY – TIME/FREQUENCY DOMAIN

**Example** – heat gradient (low thermal conductivity) generates current in thermoelectrics

- Complex Metallic Alloy -  $\text{Al}_{13}\text{Co}_4$  Quasicrystal approximant

- broadened phonon spectra revealing short phonon lifetimes and path lengths responsible for low thermal conductivity

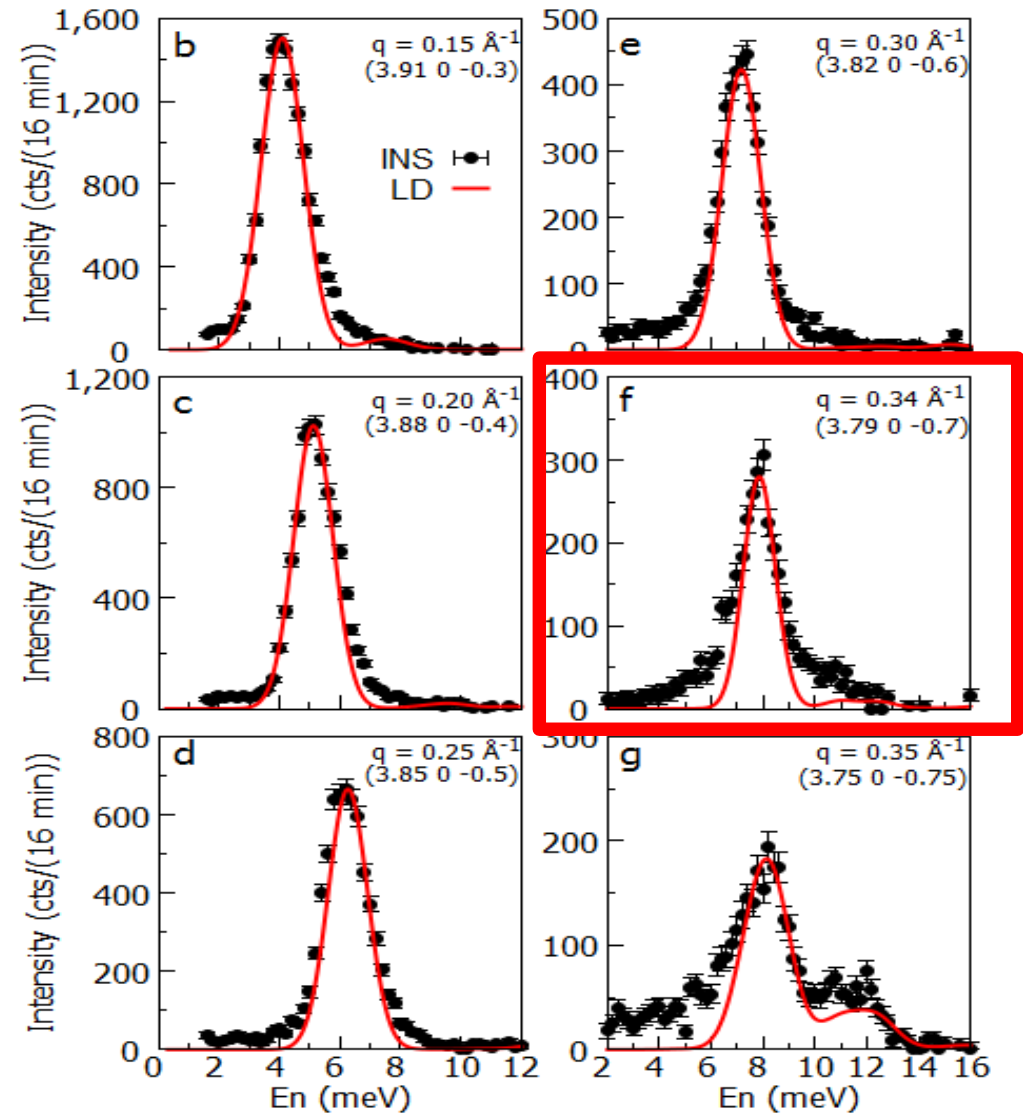
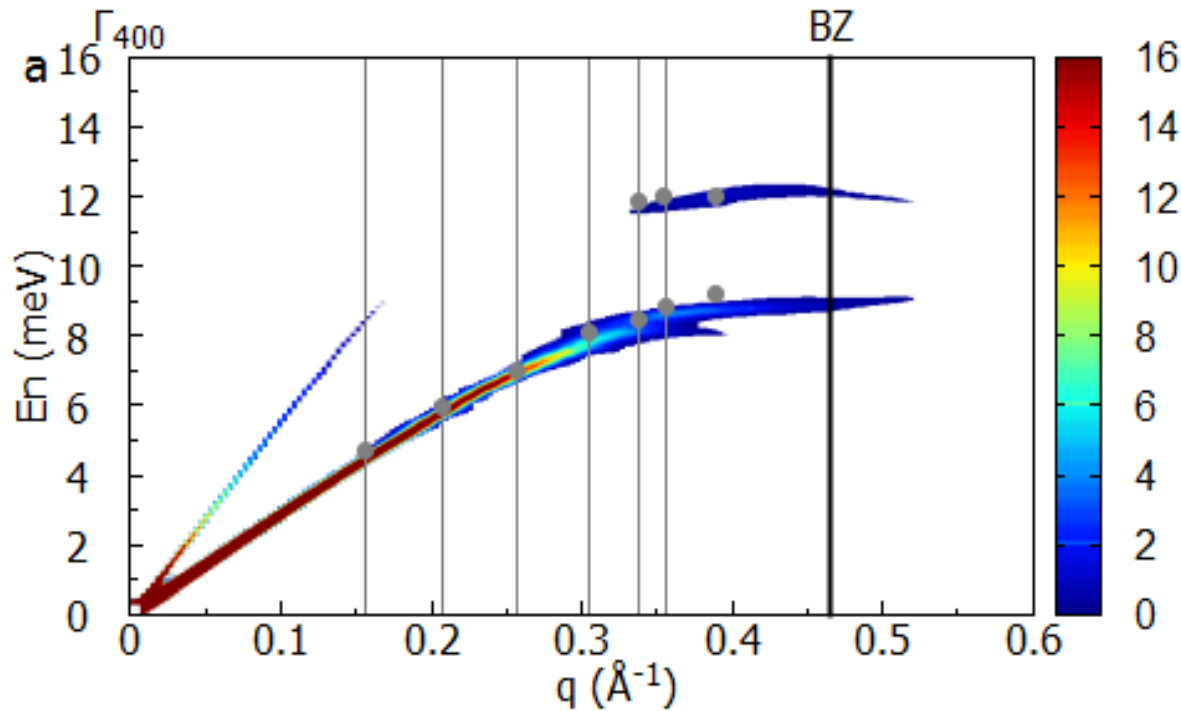

# SPECTROSCOPY – TIME/FREQUENCY DOMAIN

Simplified expressions for the scattering function  
– **incoherent scattering**

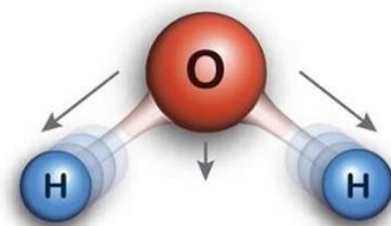

symmetric stretching

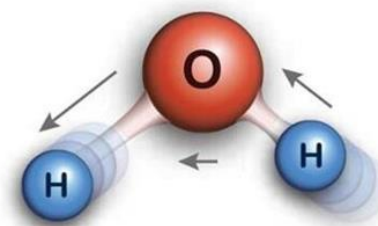

asymmetric stretching

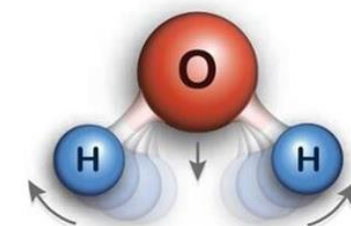

bending

In previous scattering expressions

$$R = R_0 + \delta R(t)$$

For normal modes:  $\delta R(t) \rightarrow$  displacement vectors  $\mathbf{e}$  & frequencies  $\omega$

Incoherent scattering - Internal (molecular) modes:

- No long range correlations due to weak coupling
- No dispersion

$$\left. \frac{d^2 \sigma}{d\Omega dE_f} \right)_{incoh \pm 1} = \frac{k_f}{k_i} \sum_s \delta(\omega \mp \omega_s) \frac{\langle n_s + 1/2 \pm 1/2 \rangle}{2\omega_s} \sum_r \frac{(\sigma_{incoh})_r}{4\pi} \frac{1}{M_r} \left| \vec{Q} \cdot \vec{e}_r \right|^2 \exp(-2W_r)$$



# SPECTROSCOPY – TIME/FREQUENCY DOMAIN

**Instruments** – TOF, Lagrange  
(direct & indirect spectrometers  
- fixed incident/final energies  
respectively)

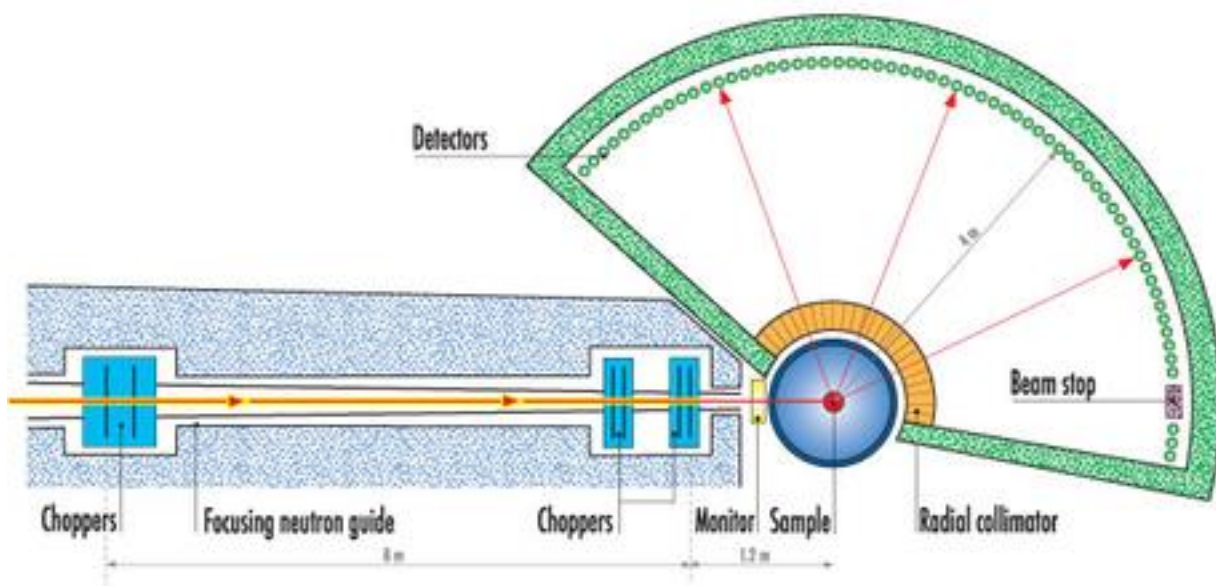
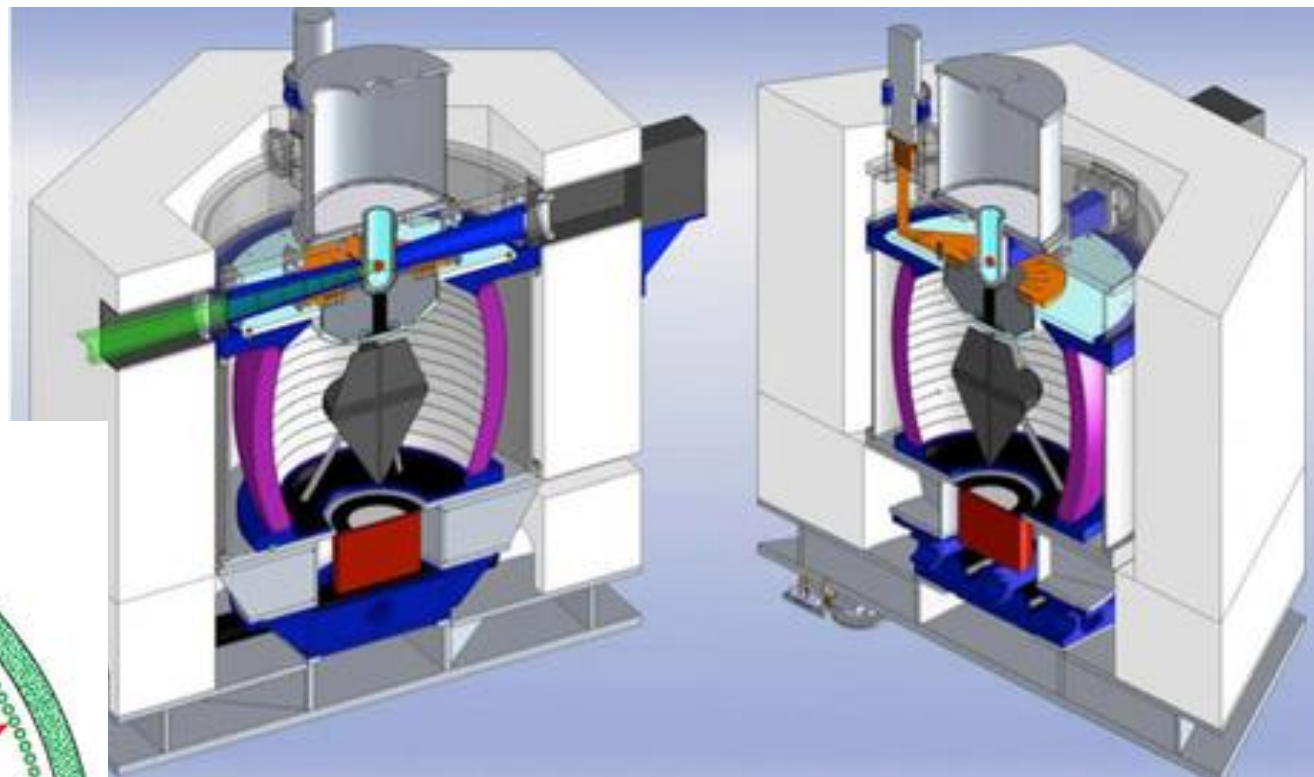

# SPECTROSCOPY – TIME/FREQUENCY DOMAIN

**Example** – endofullerenes  
 – a molecular nanolab  
 (Molecular spectroscopy –  
 no dispersion but useful Q-  
 dependence)

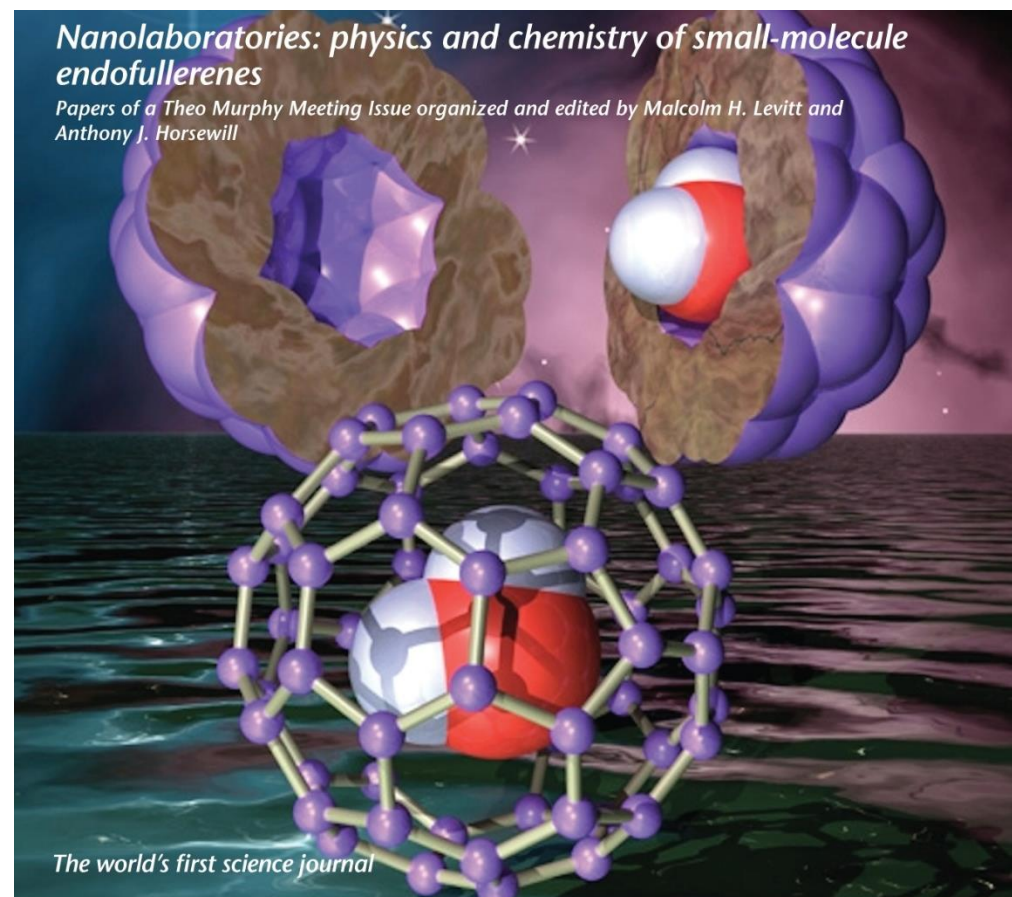
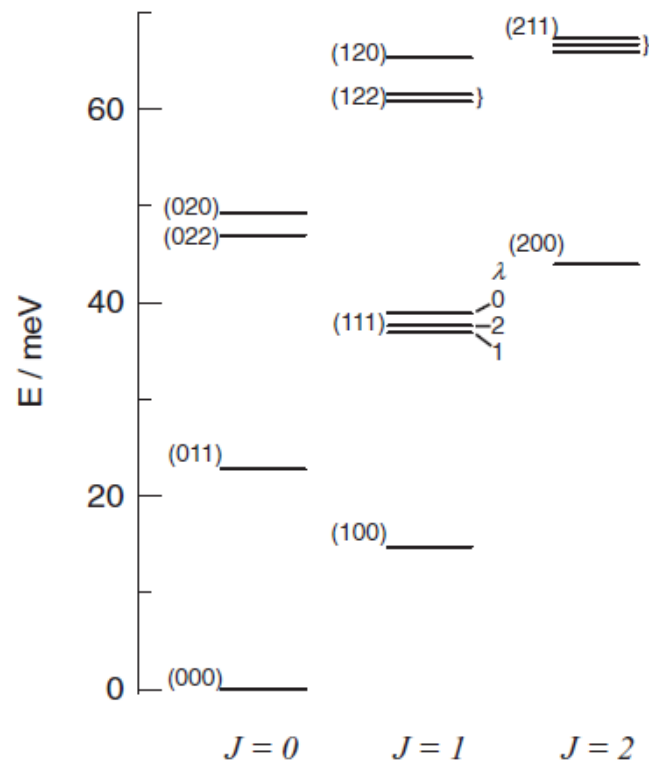

# SPECTROSCOPY – TIME/FREQUENCY DOMAIN

Example – endofullerenes

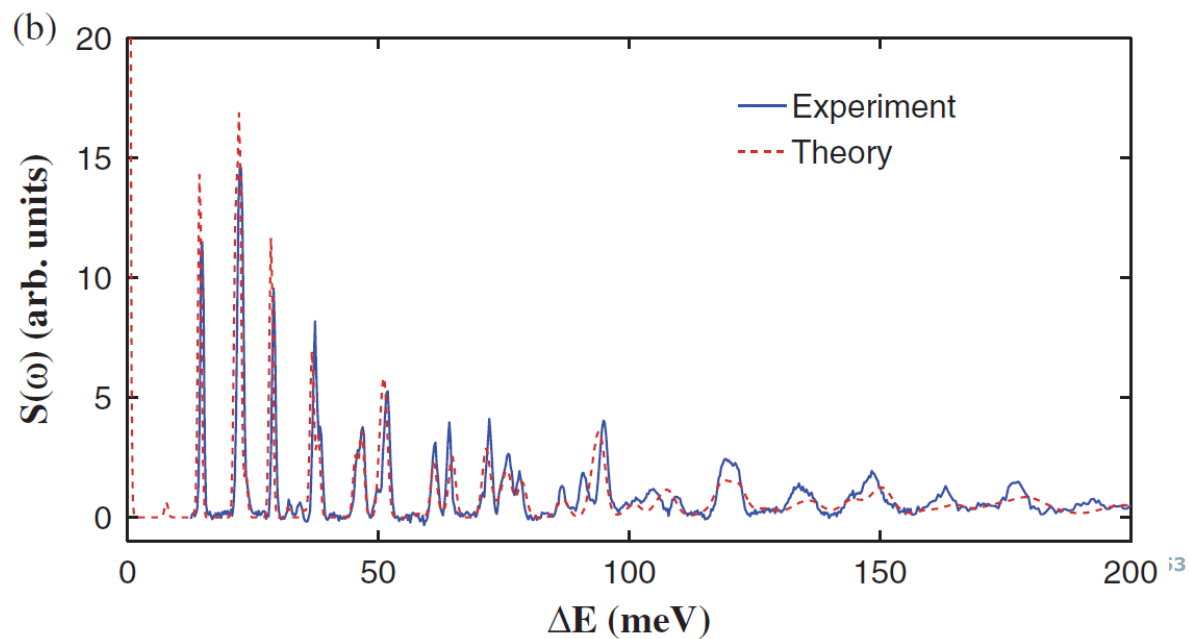
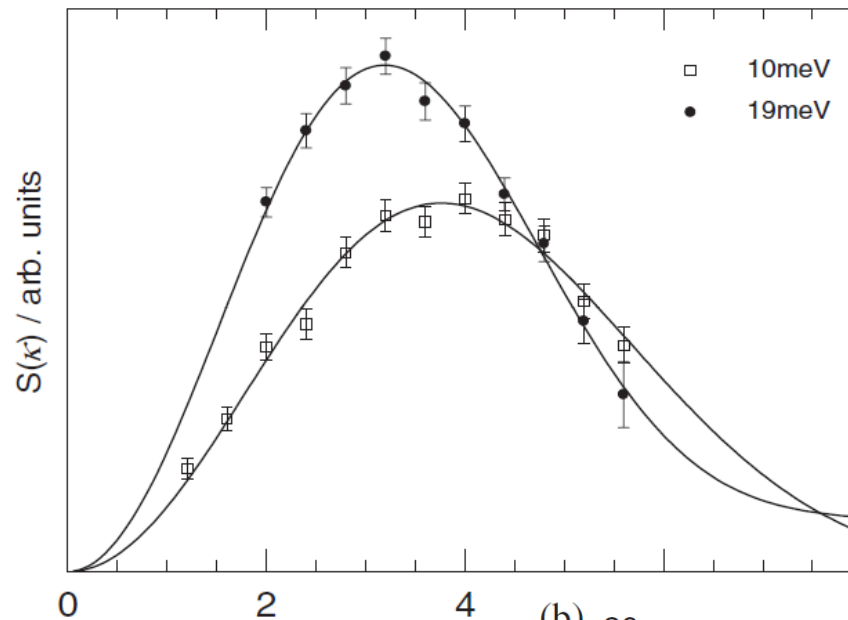
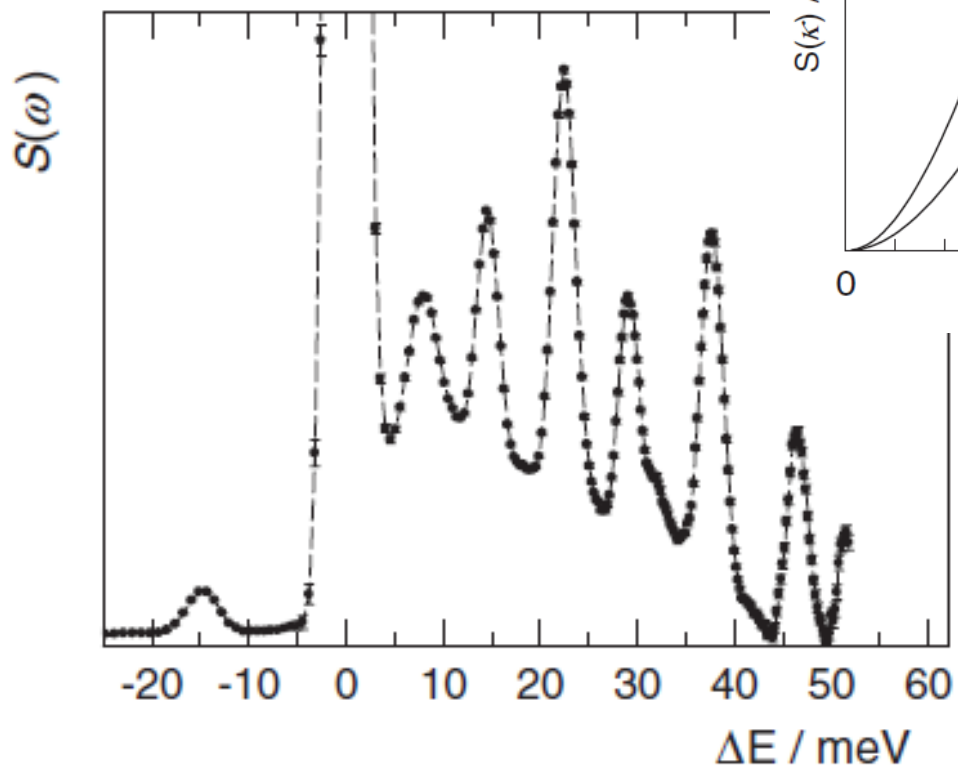



# SPECTROSCOPY – TIME/FREQUENCY DOMAIN

## Instruments – Back-Scattering

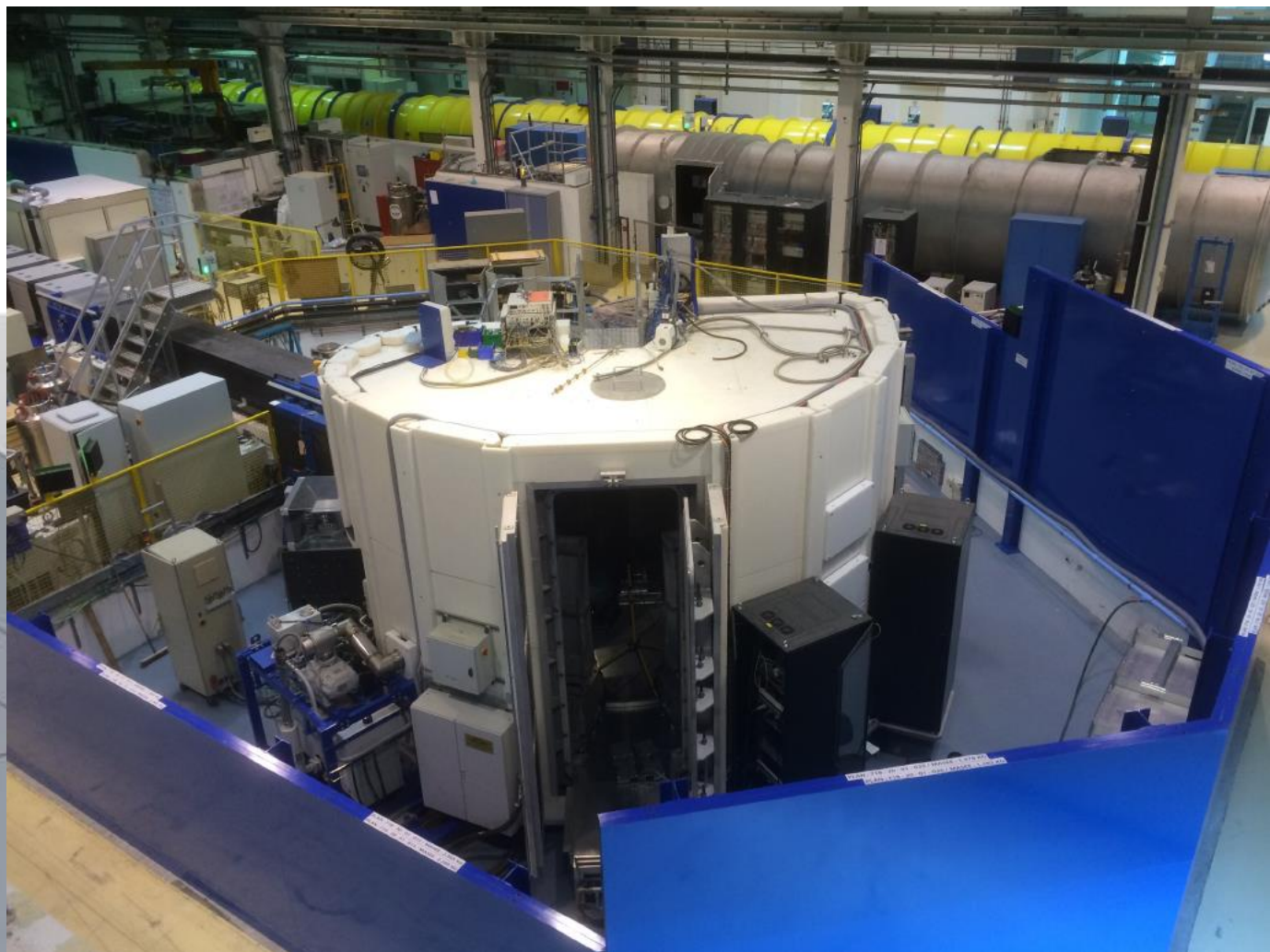
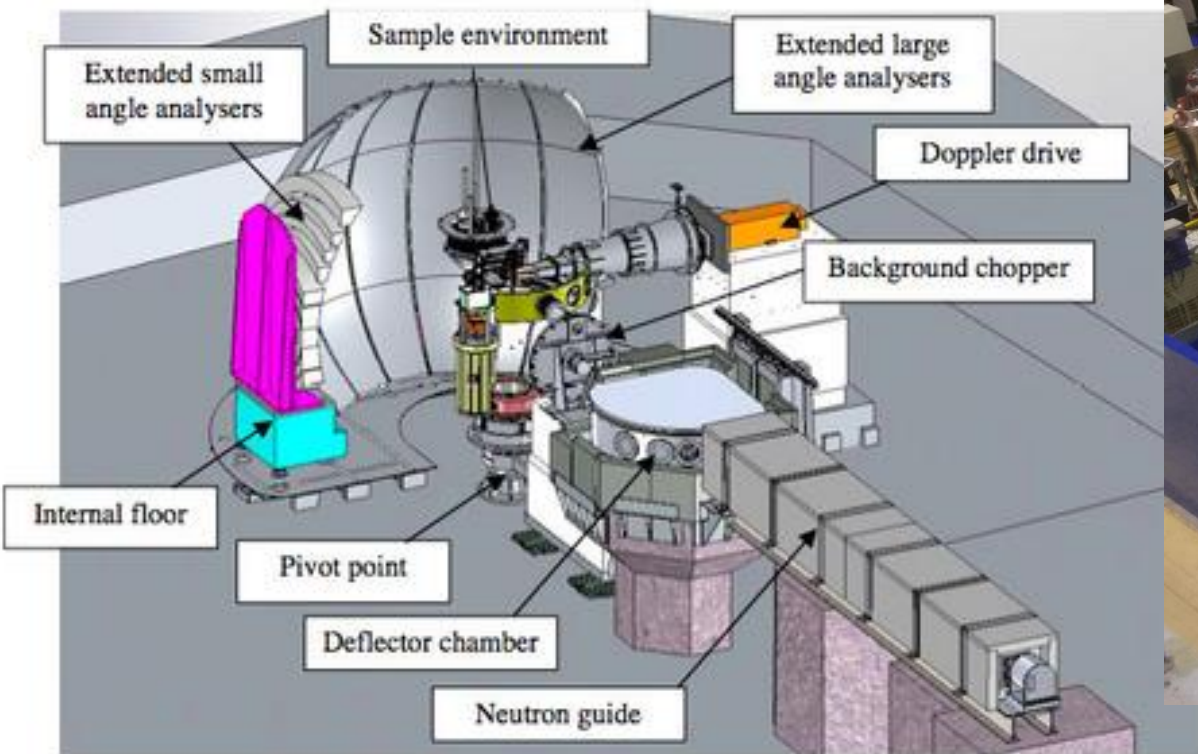



# SPECTROSCOPY – TIME/FREQUENCY DOMAIN

## Example – oxide ion conductors

Diffusion of oxygen ions through an electrolyte

Measured as a 'Doppler broadening' of the elastic peak

→ quasielastic scattering

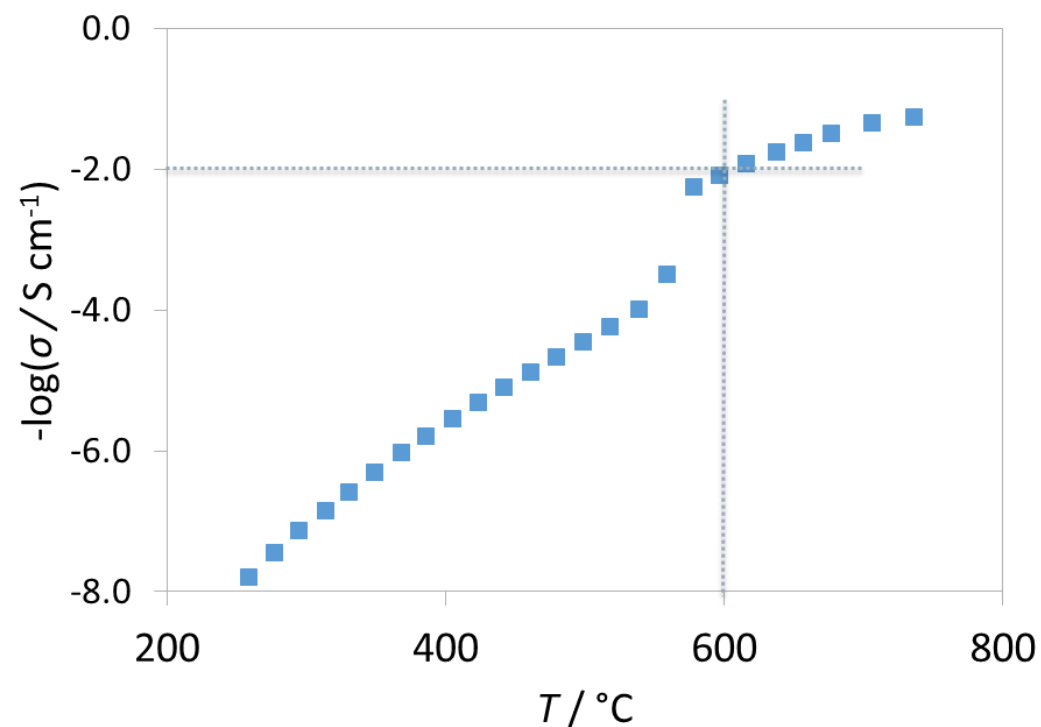
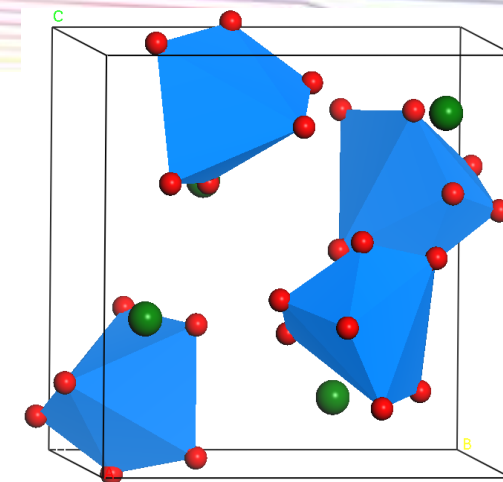
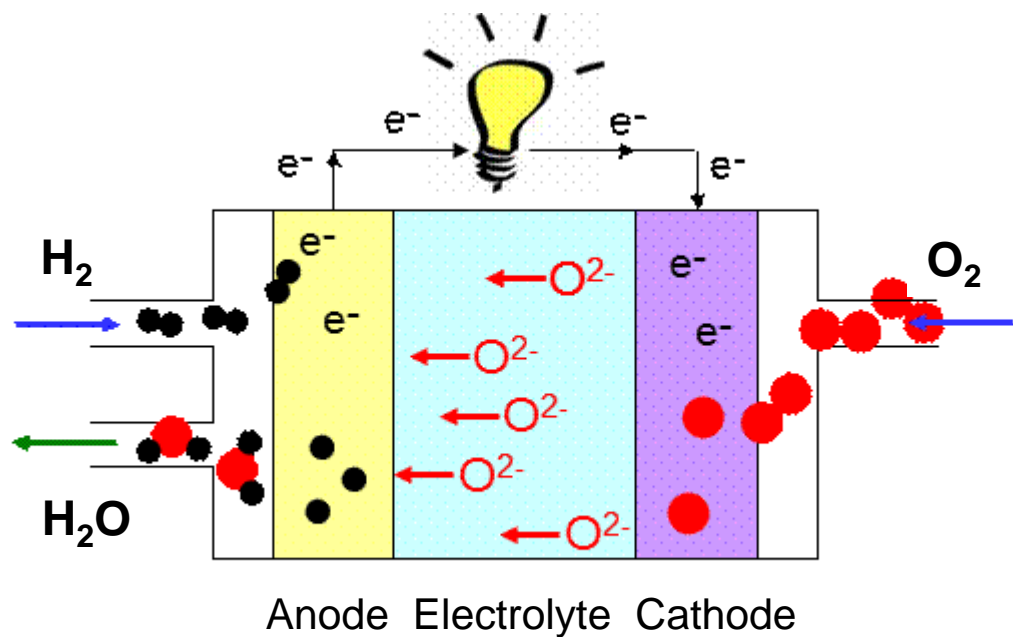

# SPECTROSCOPY – TIME/FREQUENCY DOMAIN

## Example – oxide ion conductors

Quasielastic scattering reveals ionic pathways

– details from molecular dynamics

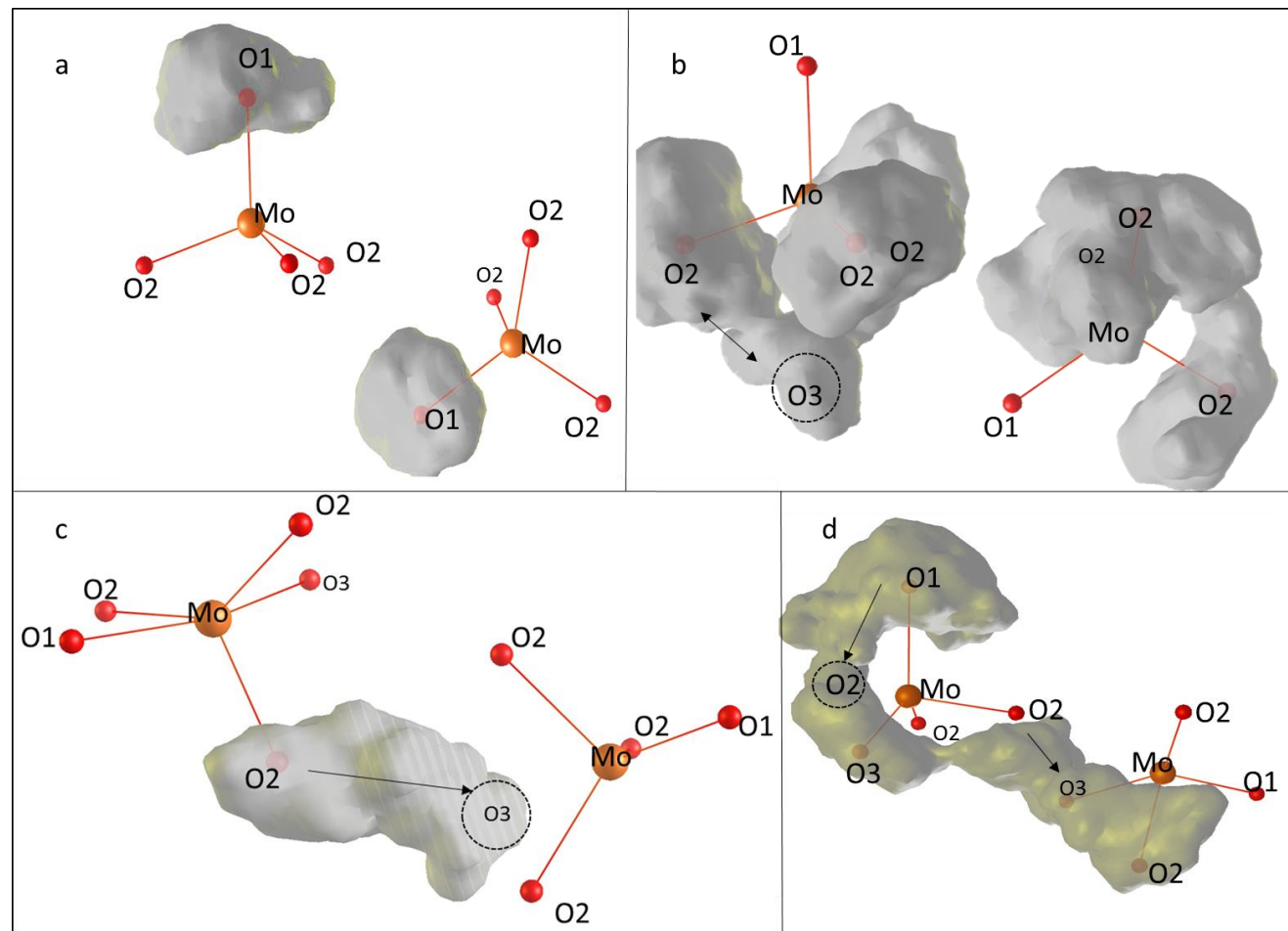
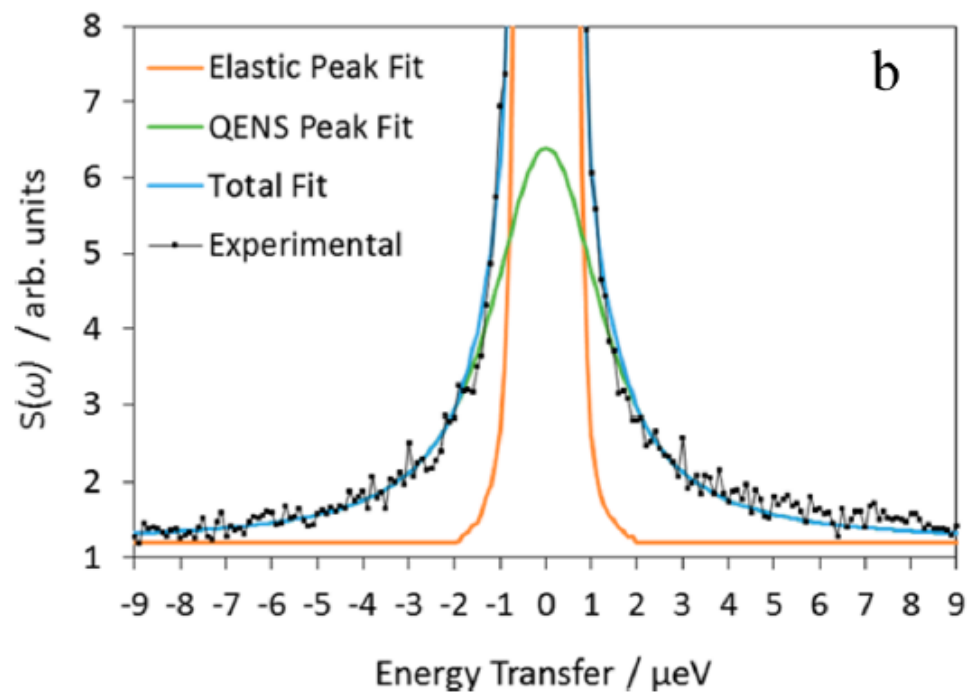

# SPECTROSCOPY – SPIN ECHO

Energy selection - precession of neutron magnetic moments in a magnetic field (depends on t.o.f. in B)

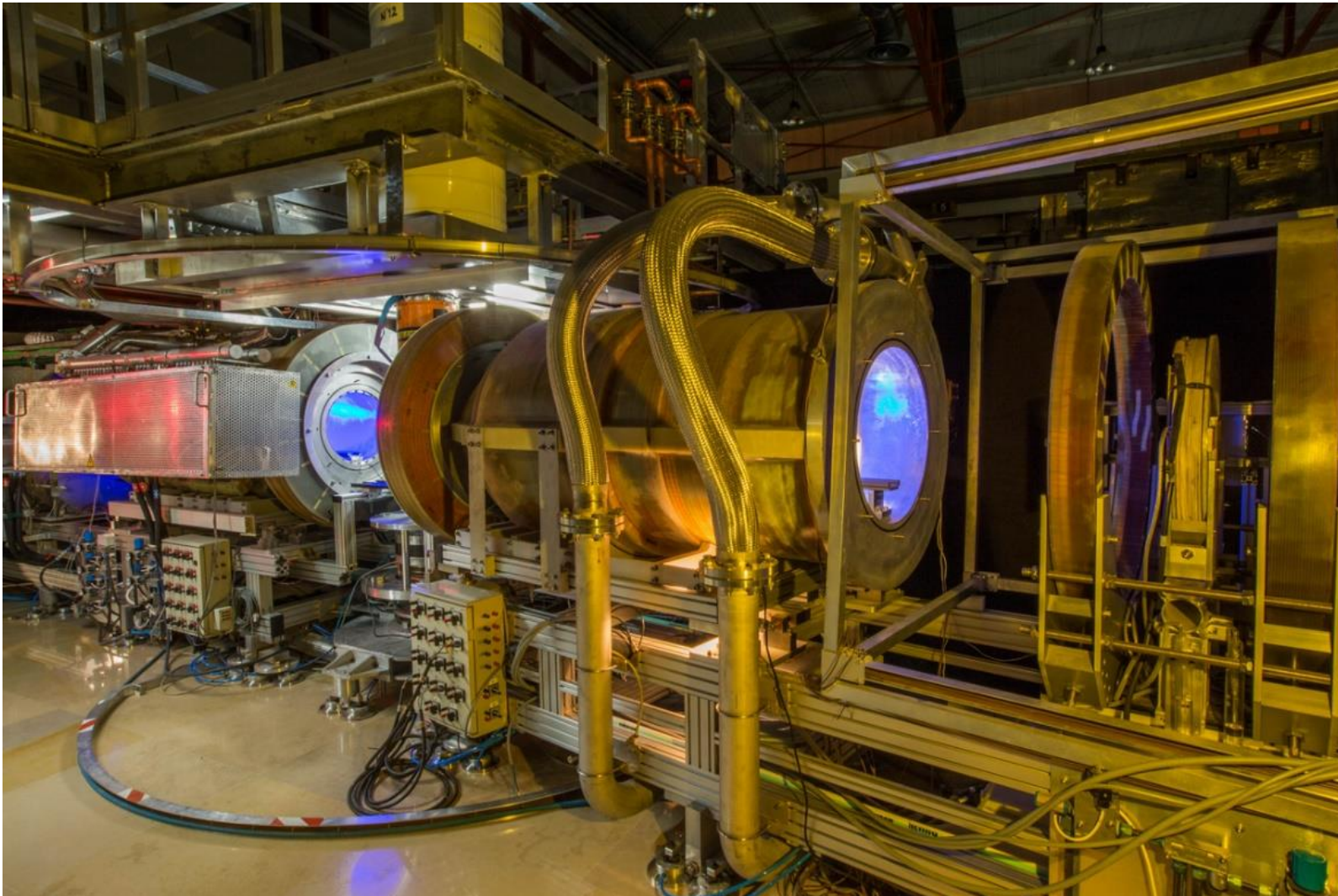



# SPECTROSCOPY – SPIN ECHO

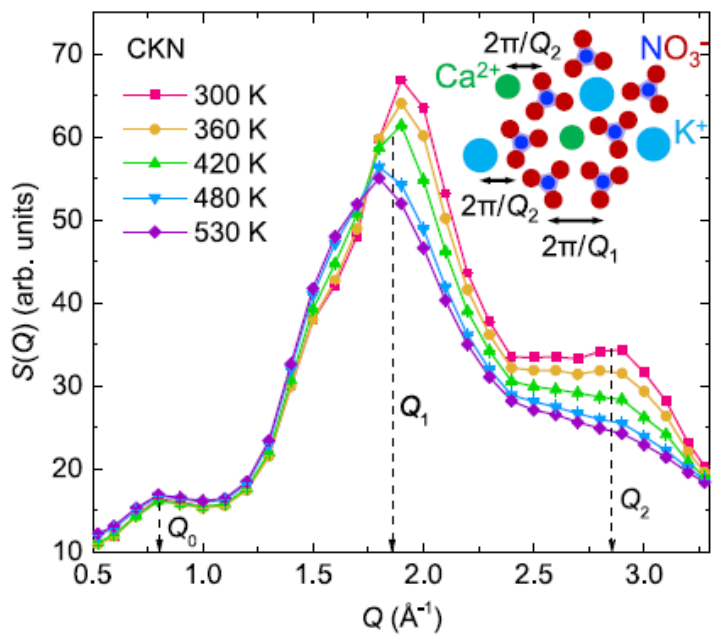
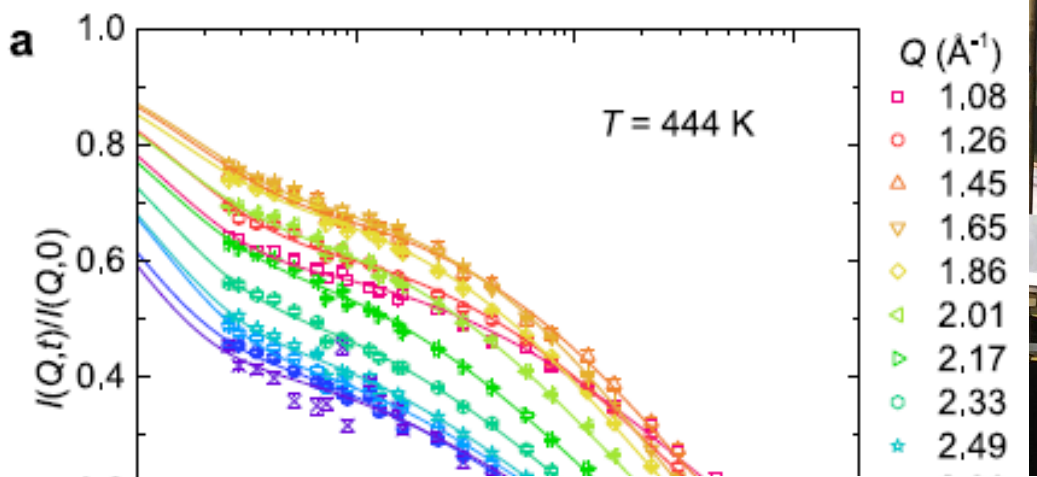
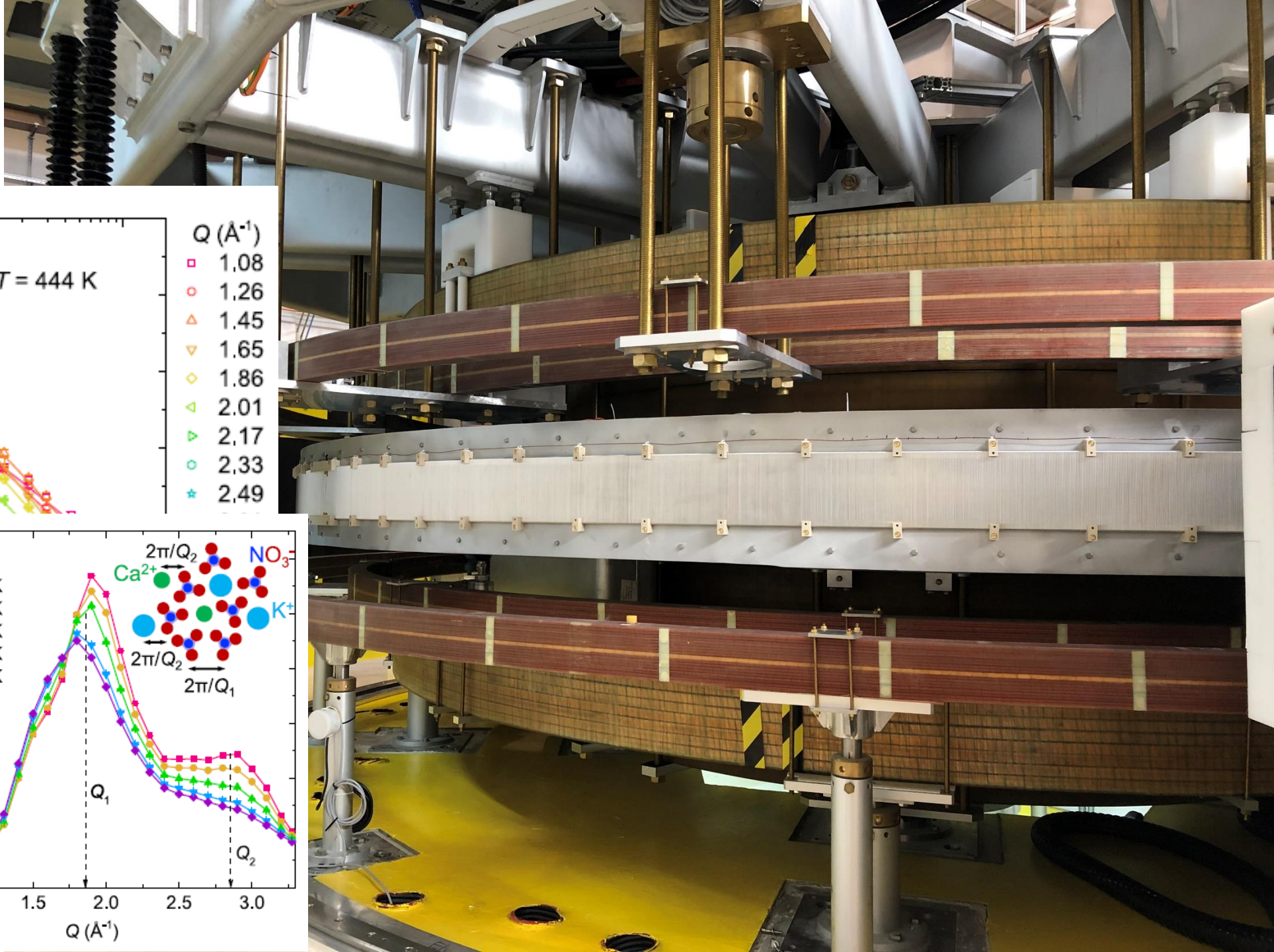

# MAGNETISM

## Structure and dynamics – double differential cross-section

As for interactions with nuclei but

- Neutron spin probes local magnetic fields due to electron spin and orbital contribution
- Atomic form factor – scattering from an atom is angular dependent due to electron cloud
- No incoherence effects
- N.B.  $\sigma$  and  $V$  in these equations

$$V_m = -\mu_n \cdot B = -\frac{\mu_0}{4\pi} \gamma \mu_N 2\mu_B \left\{ \text{curl} \left( \frac{s \times R}{R^2} \right) + \frac{1}{\hbar} \frac{p \times R}{R^2} \right\}$$

$$\left( \frac{d^2 \sigma}{dE_f d\Omega} \right)_{\sigma_i \lambda_i \rightarrow \sigma_f \lambda_f} = \frac{k_f}{k_i} \left( \frac{m_n}{2\pi \hbar^2} \right)^2 \left| \langle k_f \sigma_f \lambda_f | V_m | k_i \sigma_i \lambda_i \rangle \right|^2 \delta(E_i - E_f + E_{\lambda_i} - E_{\lambda_f})$$



# MAGNETISM

Polarised neutrons – separate nuclear and magnetic signals  
& more precise information on magnetic structures

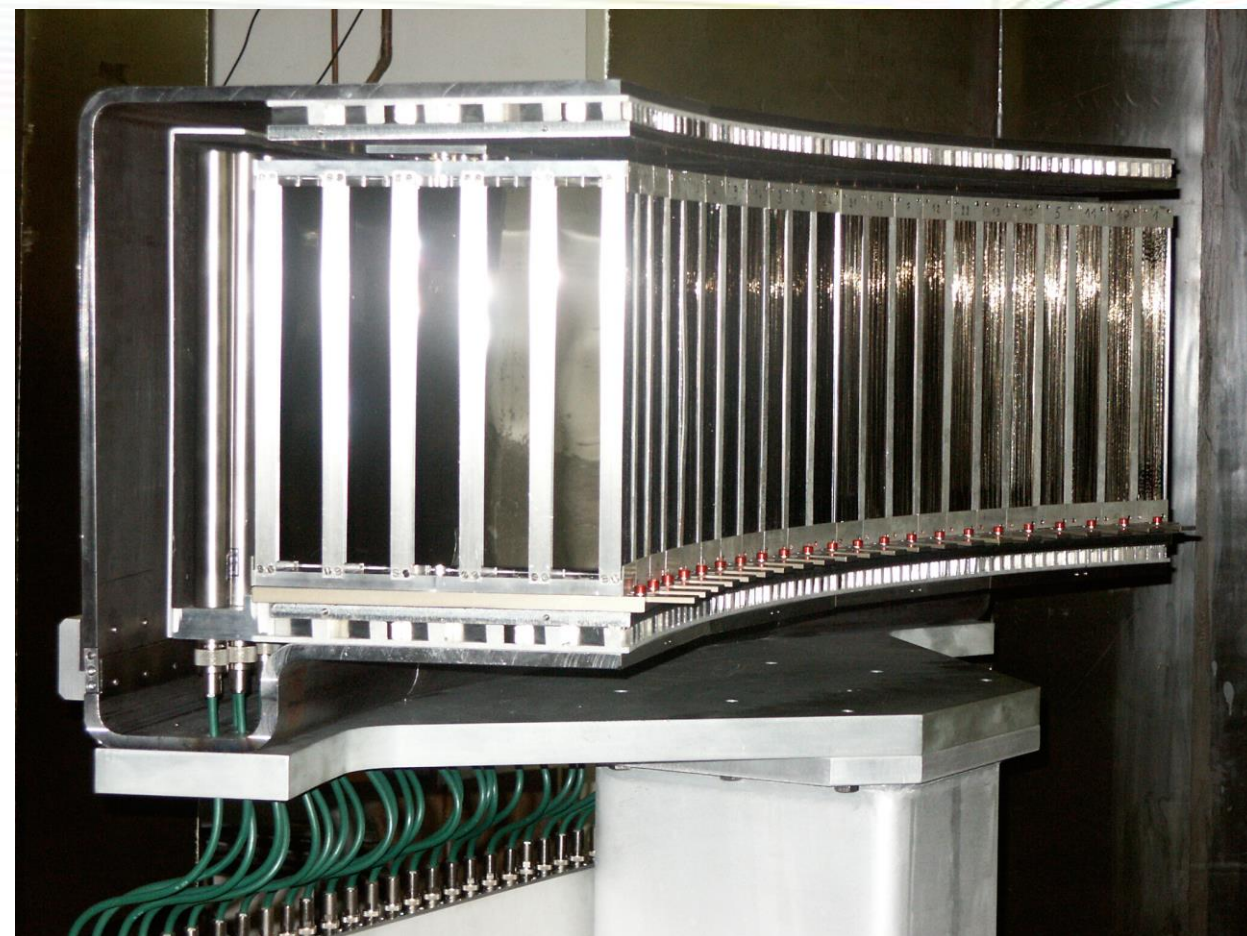
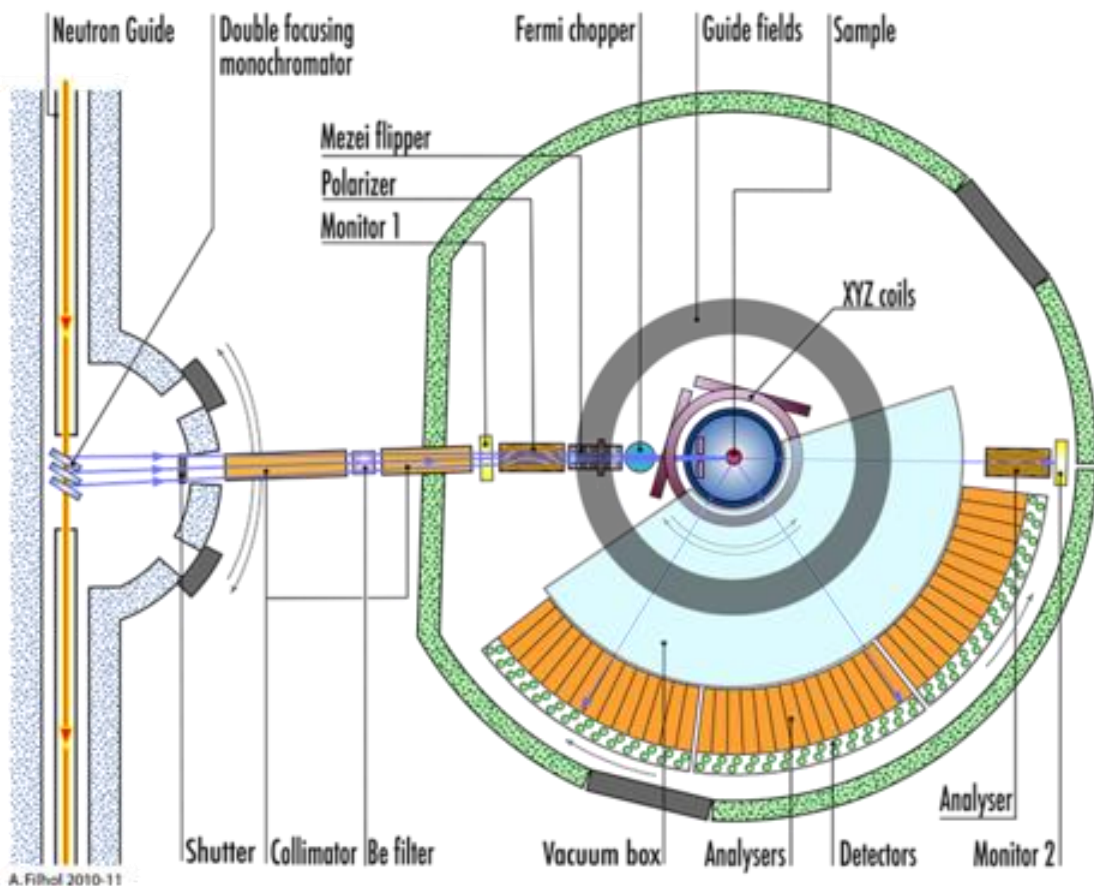

- Measure 2, 6 or 10 polarised scattering channels:  $u \rightarrow u$  (non spin flip) and  $d \rightarrow u$  (spin flip) in the simplest case



# MAGNETISM

Polarised neutrons – separate nuclear and magnetic signals  
& more precise information on magnetic structures

- Polarised (optically pumped)  $^3\text{He}$  selectively absorbs one neutron spin state – more versatile polariser
- Cryopad allows full control of incident and scattered neutron polarisation – spherical polarimetry

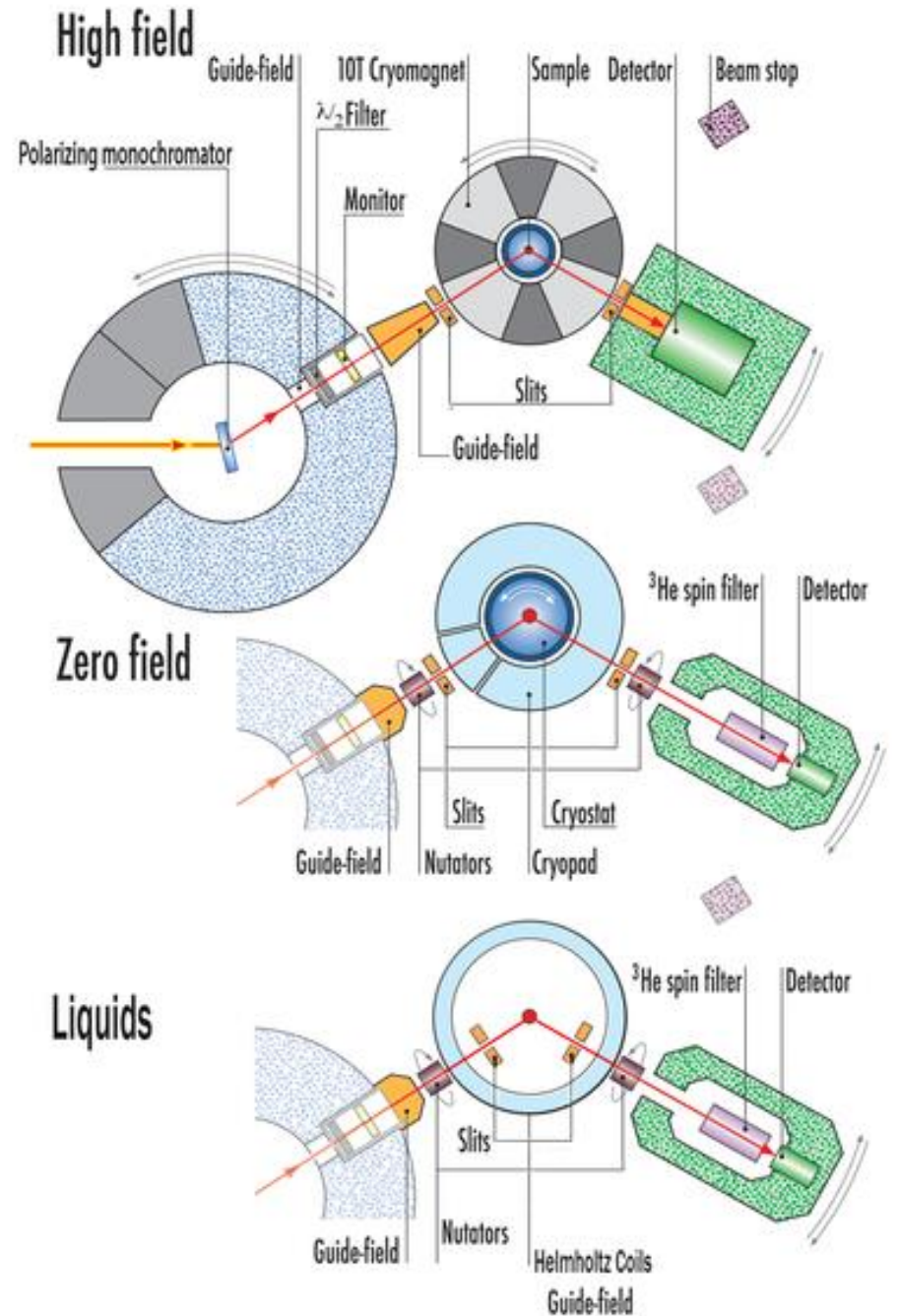
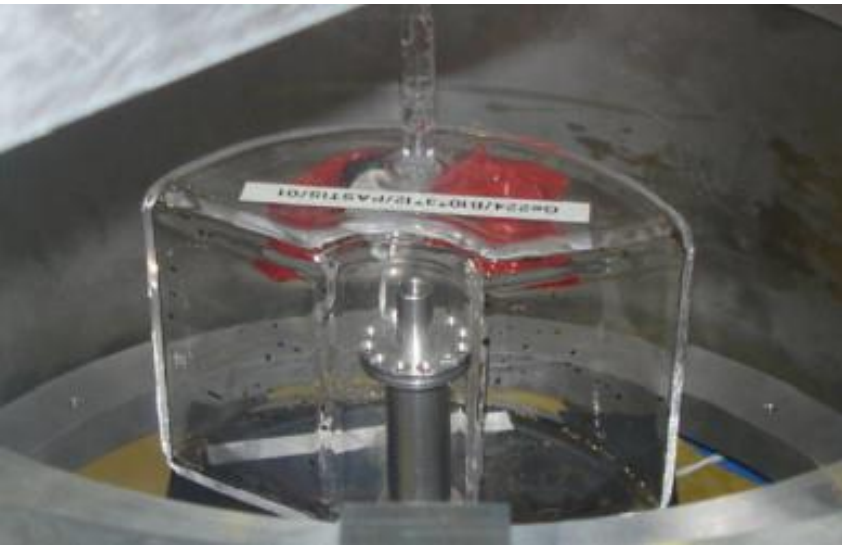

# MAGNETISM

**EXAMPLE** - SPHERICAL NEUTRON POLARIMETRY TO STUDY MAGNETOELECTRIC  $\text{CuFeO}_2$  – **0.04 mm<sup>3</sup>**

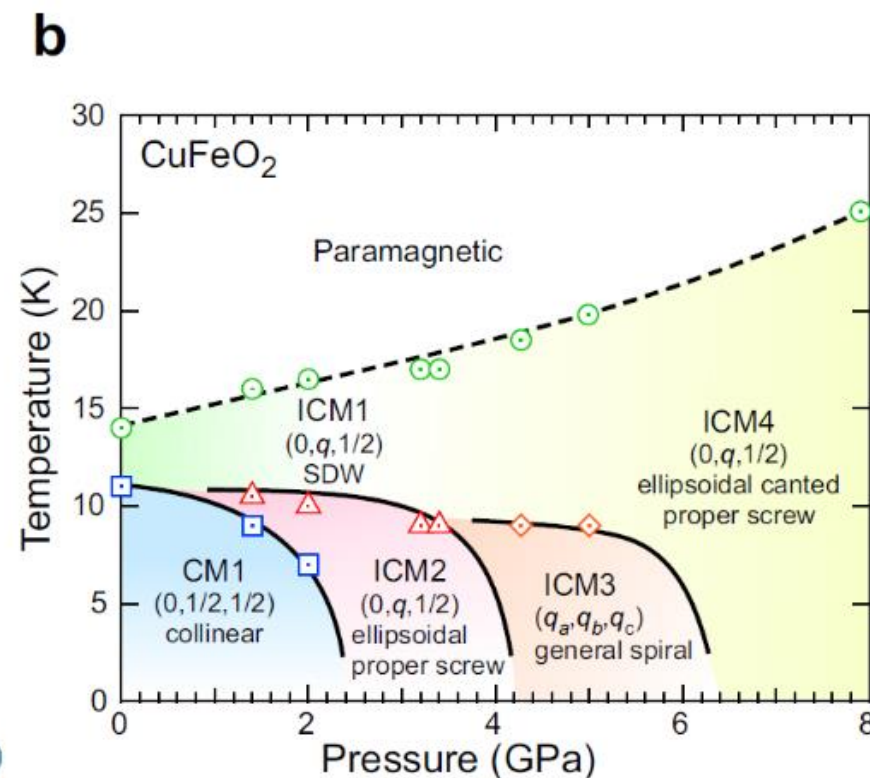
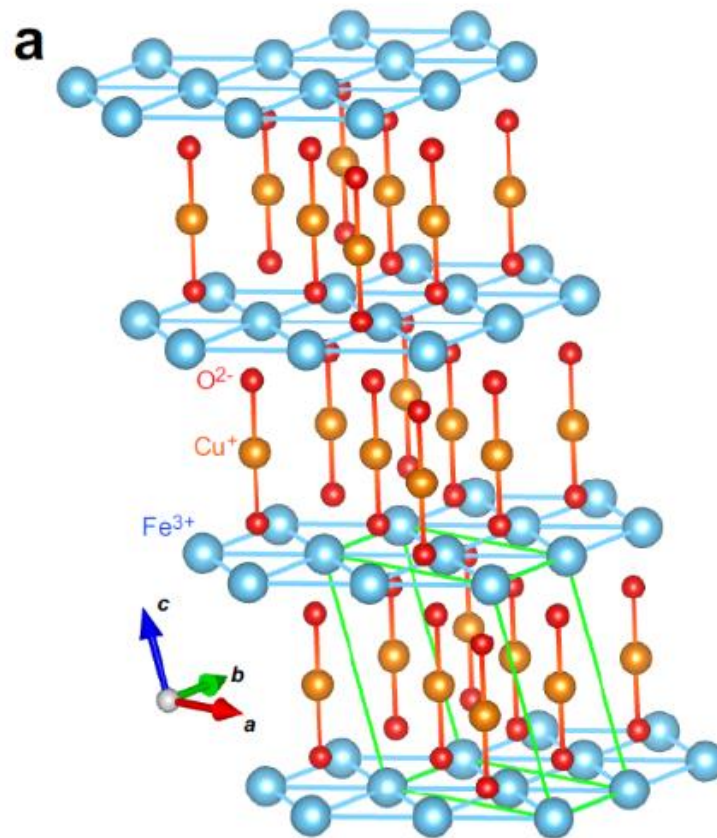
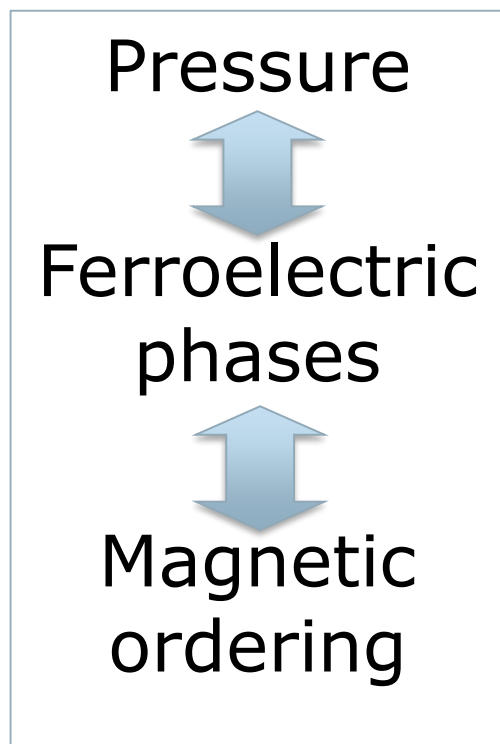



# MAGNETISM

*Nature Communications* volume 9, Article number: 4368 (2018)

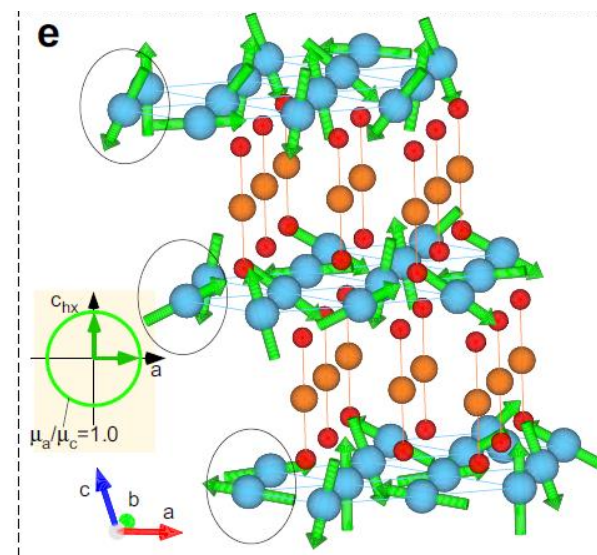
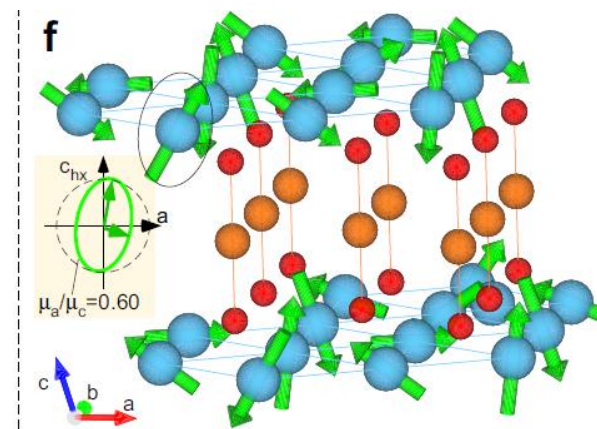
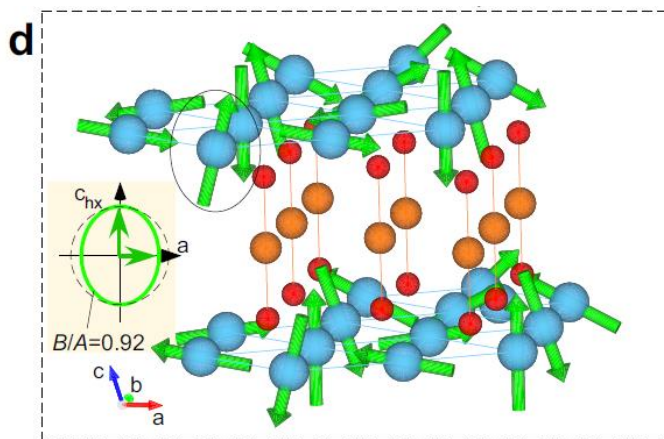
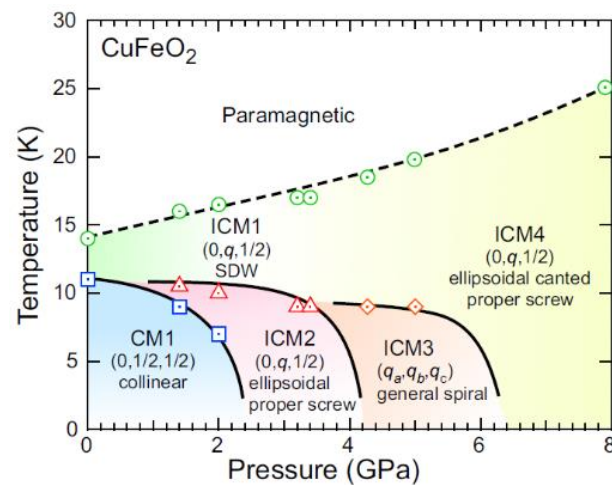
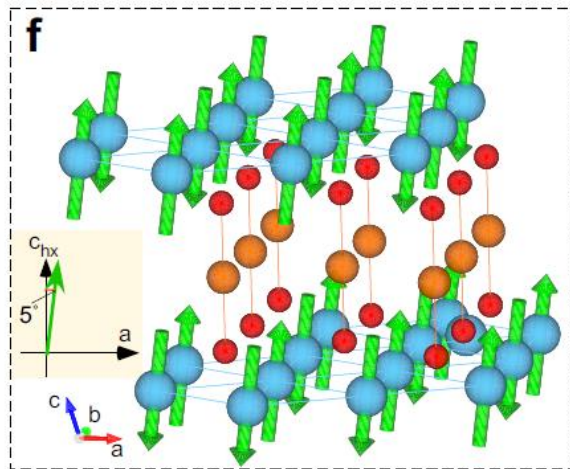
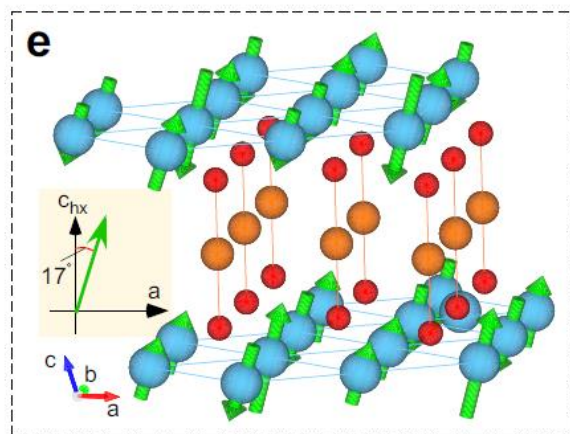



# MAGNETISM

**Example** – How do electrons/spins organise in a triangular lattice? Spins pair into quantum-mechanical bonds and fluctuate... A 'quantum spin liquid' (Anderson 1973)

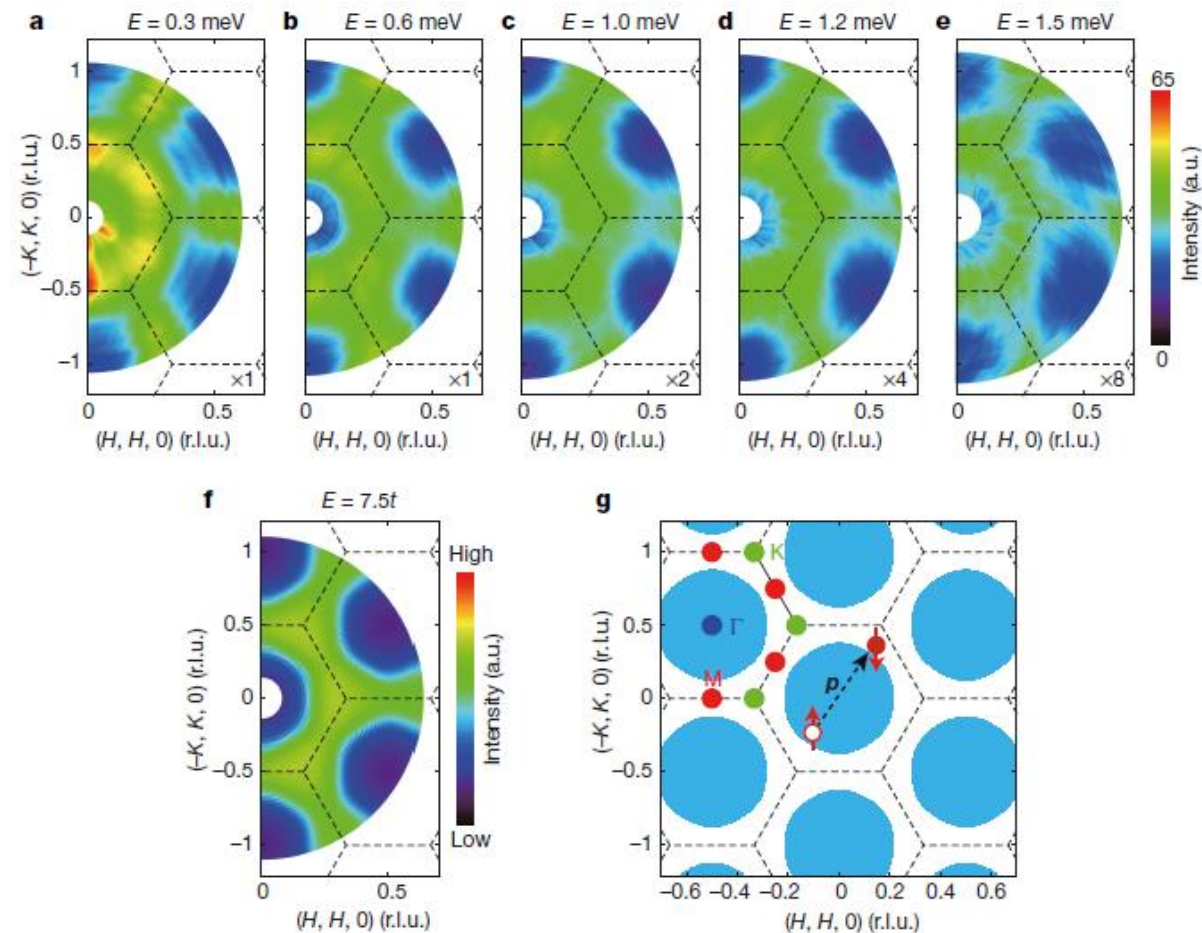
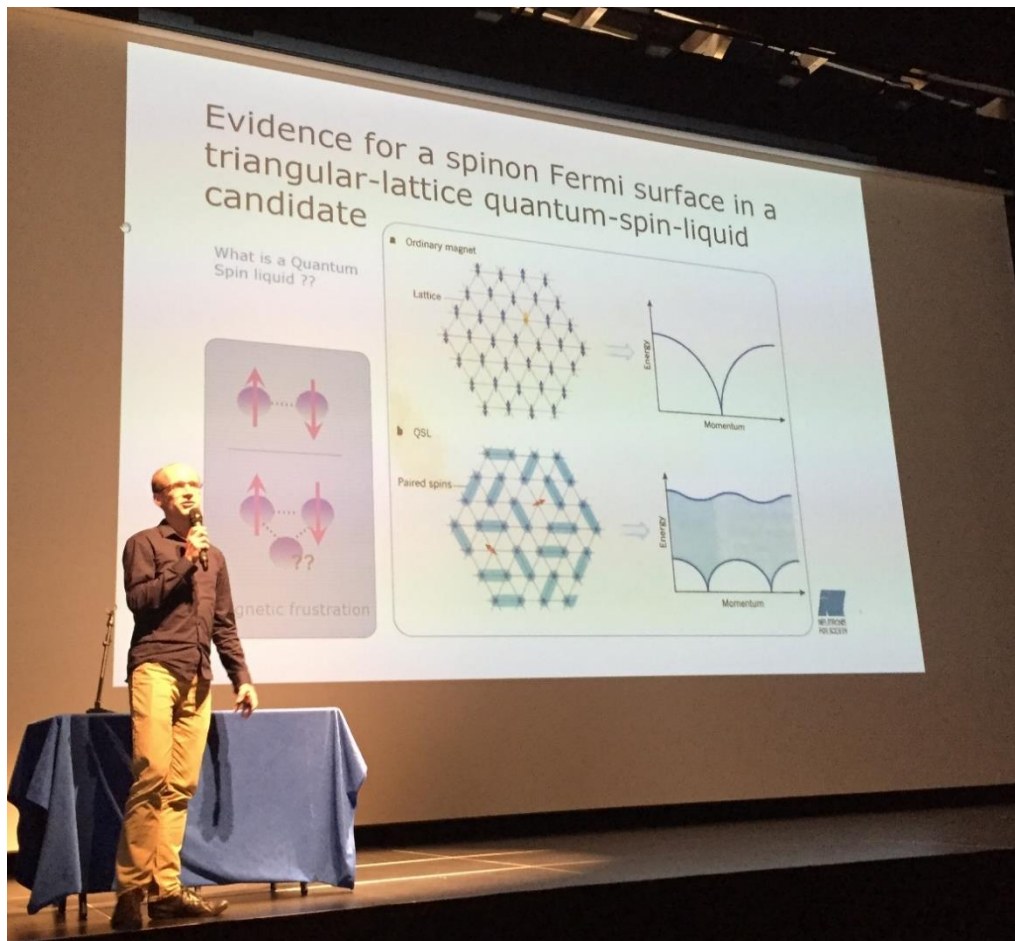

## SUMMARY – KEY MESSAGES

### The neutron

- Is Highly penetrating
- Interacts with nuclei – favourable for light atoms (H, Li, O,...)
- Incoherent scattering is ideal for proton dynamics
- Isotopes provide selectivity – contrast matching
- Interacts with unpaired electrons – magnetism
- Probes 15 orders of magnitude in length & 10 in time

Neutron sources have relatively low intensity and are only available in large scale facilities – ILL, ISIS, PSI, FRM2 in Europe, SNS & NIST in US

# ADDITIONAL READING

Search the web! Plus...

- [Principles of Neutron Scattering from Condensed Matter \(ox.ac.uk\)](https://www.ox.ac.uk) [www link]
- *Andrew Boothroyd (2020) Oxford University Press*
  
- *Introduction to the Theory of Thermal Neutron Scattering*
- G.L. Squires (1997) Reprint edition, Dover publications ISBN 04869447
  
- *Experimental Neutron Scattering*
- B.T.M. Willis & C.J. Carlile (2009) Oxford University Press ISBN 978-0-19-851970-6
  
- *Neutron Applications in Earth, Energy and Environmental Sciences*
- L. Liang, R. Rinaldi & H. Schober (2009) Eds Springer ISBN 978-0-387-09416-8
  
- *Methods in Molecular Biophysics*
- I.N. Serdyuk, N. R. Zaccai & J. Zaccai (2007) Cambridge University Press ISBN 978-0-521-81524-6
  
- *Thermal Neutron Scattering*
- P.A. Egelstaff ed. (1965) Academic Press



# ENJOY YOUR MONTH ON THE EPN CAMPUS



# VERCORS



08/09/2023



# CHARTREUSE





# MONT BLANC



08/09/2023