



Commissioning of the ALS Third Harmonic Cavities

John Byrd

ALS Accelerator Physics Group

contributions from: Stefano DeSantis, Mattias
Georgsson (MAXLab), Greg Stover, John
Fox(SLAC), Dmitry Teytelman (SLAC)

The Advanced Light Source



ALS Operating mode

- Fills from 400-200 mA in 6 hours
- Injection at 1.5 GeV, ramp to 1.9 GeV. 2/3->3/4 yr at 1.9 GeV.
- Longitudinal and transverse stability maintained at all times (i.e. MBFB systems always on.)
- All gaps controlled by users except W16.
- Transverse emittance coupling adjusted to about 3% to allow for minimum 4 hrs/fill.
- Slow orbit feedback at 0.1 Hz.

Nominal Energy	1.5 GeV
Circumference	194.8 m
RF frequency	500 MHz
harmonic number	328
revolution frequency	1.52 MHz
bunch current	1-2 mA
mom. compaction	1.4×10^{-3}
energy spread	7×10^{-4}
typical bunch length	4.5 mm
long. damping time	13 msec
radiation loss/turn	90 eV
hor. emittance (1.9 GeV)	4×10^{-9}

Harmonic RF system



J. Akre, K. Baptiste, A. Biocca, J. Byrd, D. Calais, C. Cummings, S. De Santis, M. Franks (LLNL), J. Harkins, T. Henderson, J. Julian, C.C. Lo, R. Rimmer, D. Plate, E. Yee

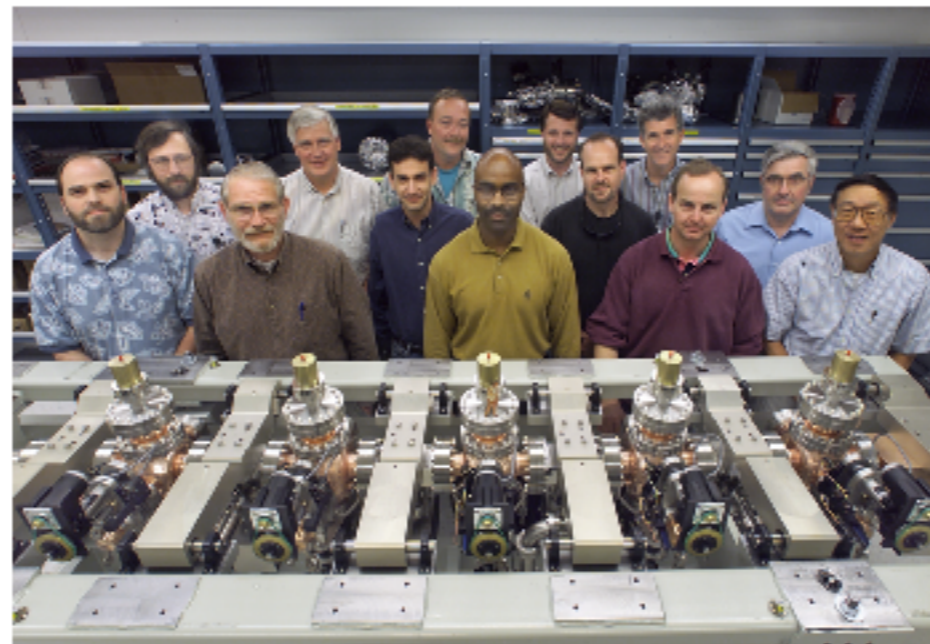

ALS Beam Lifetime



- determined by Touschek and gas scattering

$$\left(\frac{1}{\tau}\right)_{\text{total}} = \left(\frac{1}{\tau}\right)_{\text{Touschek}} + \left(\frac{1}{\tau}\right)_{\text{gas}}$$

- Under normal conditions the Touschek scattering dominates

$$\left(\frac{1}{\tau}\right)_{\text{Touschek}} \propto \frac{1}{\varepsilon^2 \gamma^4 \sigma_x \sigma_y \sigma_z}$$

Options for lifetime increase:

- Increasing the transverse beam area =>decreases the brightness up to a limit where coupling reduces momentum acceptance.
- decrease the current/bunch=>run with smaller or no gap.
- increase momentum acceptance=>already at maximum RF voltage
- increase the bunch length=>harmonic cavities

Bunch lengthening with harmonic RF

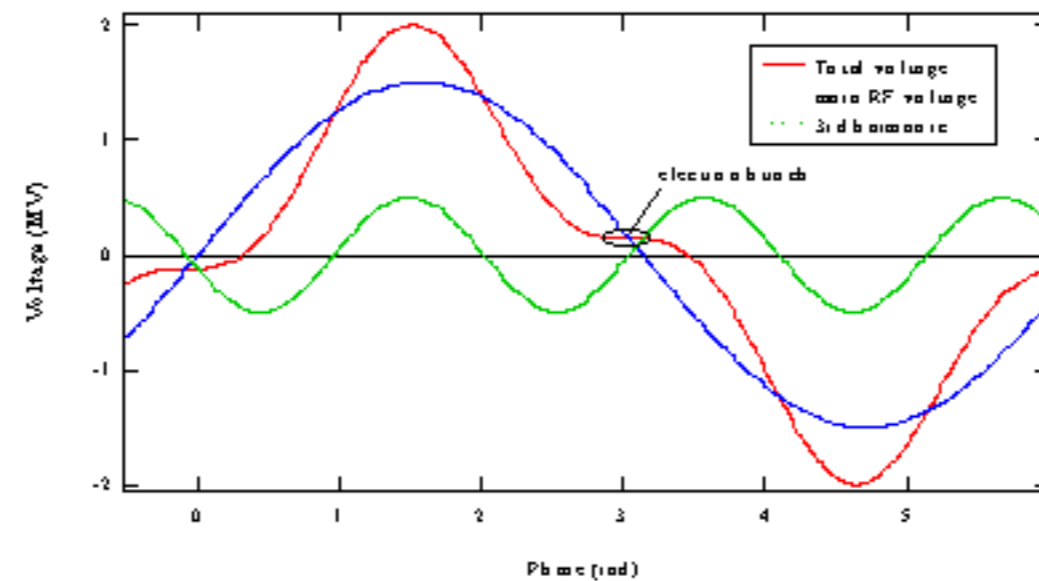

- Gaussian energy spread from quantum excitation from photon emission.
- A single RF system forms a quasi-harmonic potential well resulting in harmonic synchrotron oscillations. This results in a Gaussian longitudinal charge distribution.
- To modify the distribution, add a harmonic RF voltage with frequency $n \cdot F_{RF}$.
- For maximum bunch lengthening, the harmonic voltage should cancel the slope of the main RF voltage at the bunch center. Optimum voltage is $\sim V_{RF}/n$.

Longitudinal distribution and lifetime



The lifetime improvement can be found by

$$R = \frac{\tau_{kc}}{\tau_N} = \frac{\sigma_{kc}^2}{\sigma_N^2} \frac{\int dz \rho_N^2}{\int dz \rho_{kc}^2}$$

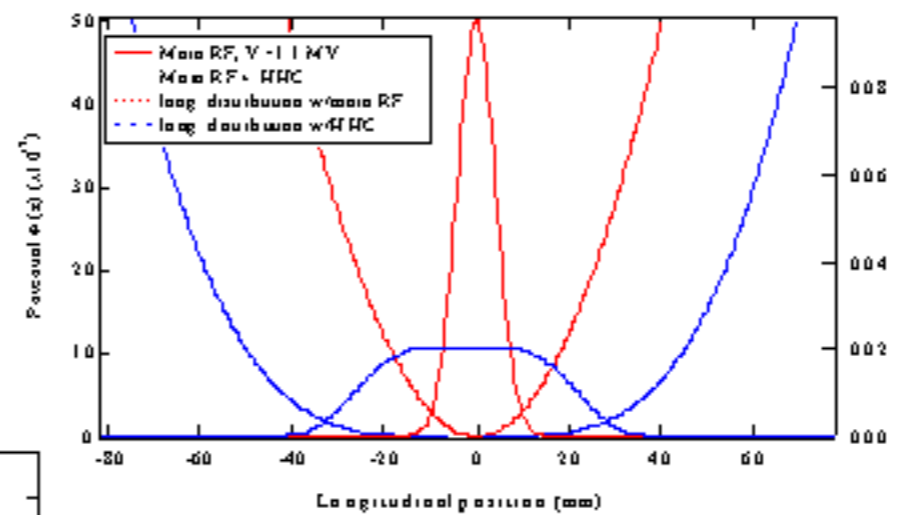
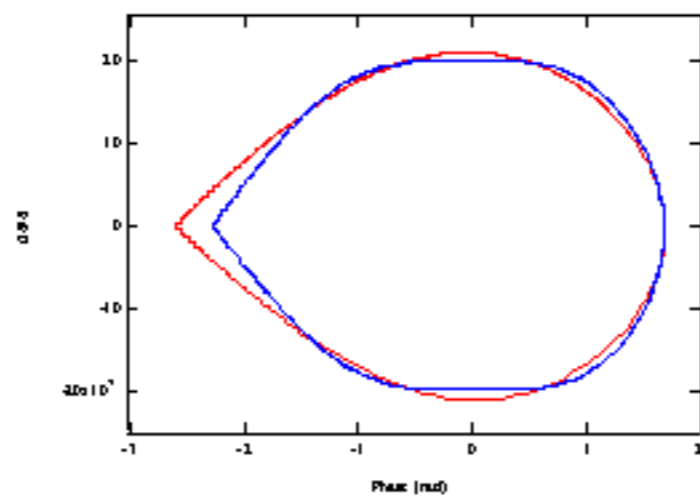

The distorted RF acceptance decreases slightly, reducing the lifetime improvement.

Passive Cavity Operation



Cavity is tuned above 1.5 GHz current harmonic to excite voltage for bunch lengthening.

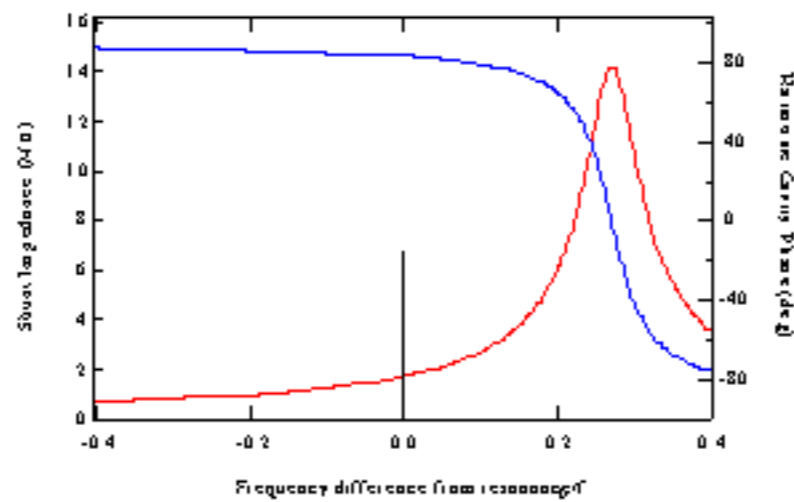

We plan to adjust the tuner to maintain a constant cavity voltage.

To find optimum tuning position, plot lifetime improvement vs. resonant frequency for several beam currents for a fixed beam-induced voltage.

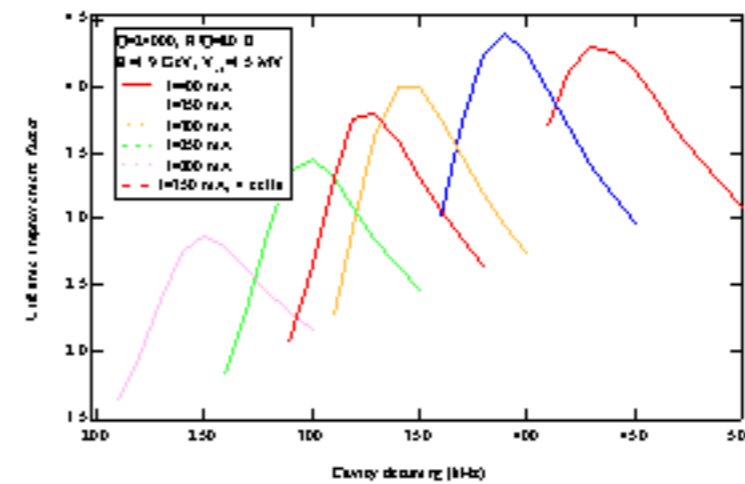

Project Design



- Install 5-1.5 GHz Cu cavities in second half of straight 2.
- Cavities designed at LBNL and manufactured at LLNL by team which built PEP-II B-Factory cavities.
- Operate in passive mode with cavity voltage excited by beam. Cavity voltage adjusted by tuning cavity frequency.
- Allow for “parking” of cavities in case of problems.
- Improve beam lifetime by a factor of 3 depending on beam energy and current while maintaining 3-d beam stability.

Cavity Design



Cavity parameters:

$V = 100 \text{ kV/cell}$ $P_{\text{max}} = 5 \text{ kW}$

$R/Q = 80.4 \Omega$ $Q = 21000$

$R = 1.7 \text{ M}\Omega$

- Cavity made from two end lids e-beam welded to main body. Milled from 2" and 4" Cu plate.
- cooling channels are milled into lid and body and then electroplated.
- bottom port used for main tuner, side port for secondary tuner, other side port for RF probe and input port is capped with an arc detector.
- design consistent with upgrading to active system.
- HOM damping antenna planned for top port.

Cavity shape and RF features designed by Bob Rimmer. Mechanical design by Dave Plate.

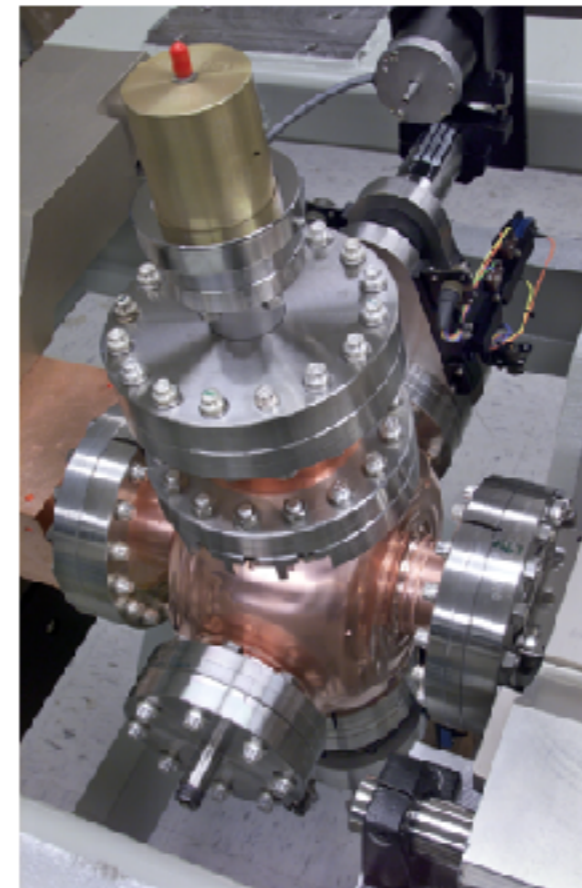

Commissioning Results



- **Harmonic cavity effects**
 - lifetime increase
 - bunch length increase
 - synchrotron frequency shift
 - Landau damping
- **Performance limitations**
 - cavity HOMs
 - synchronous phase transients
 - retuning of LFB system

Lifetime increase

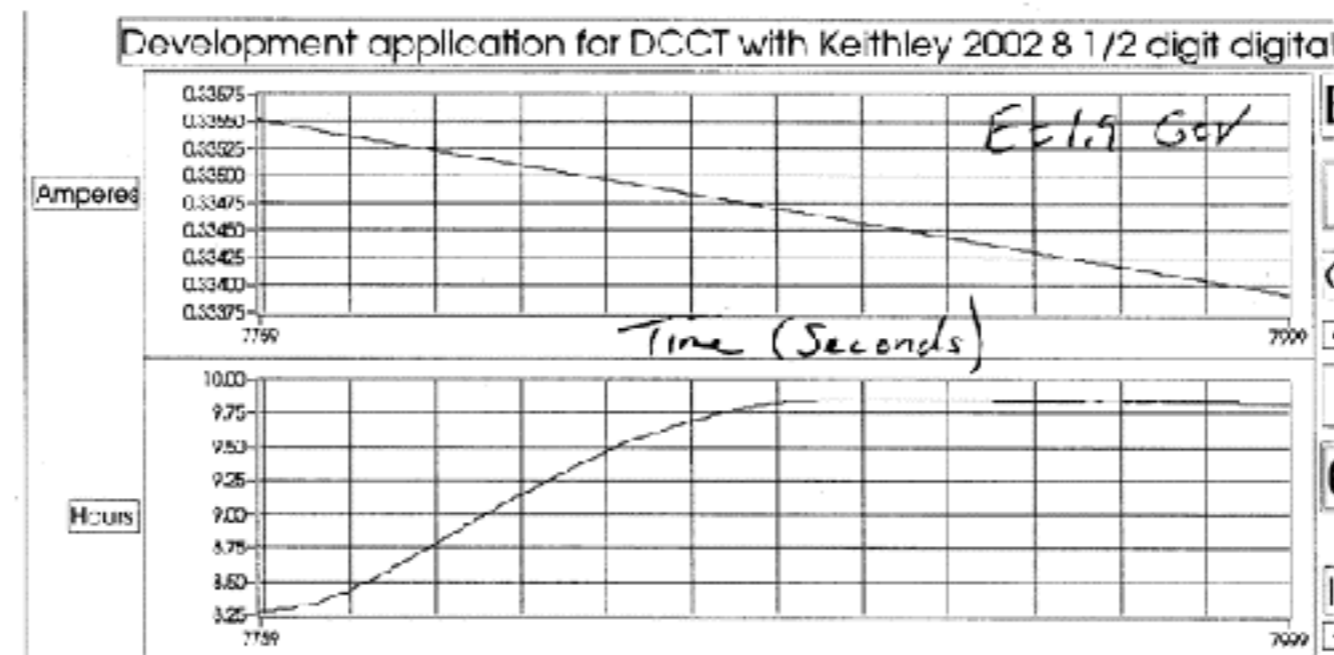

...as the cavities are tuned in.

Best result to date is 9 hr lifetime at 400 mA w/small gap in fill pattern (10 hr w/gaps closed)

Bunch length increase



We can observe bunch lengthening on a visible streak camera.

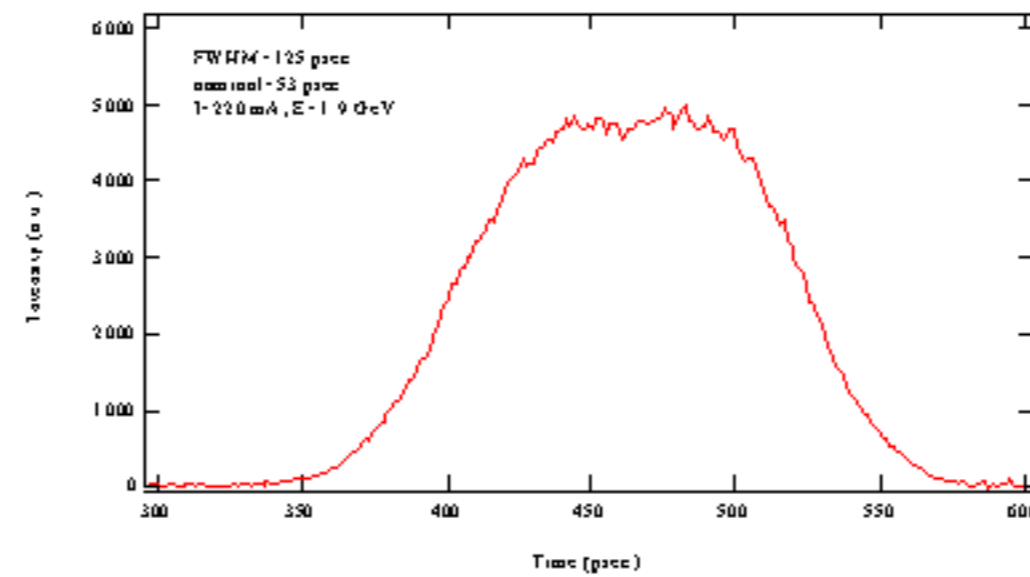

Synchrotron Frequency Shift

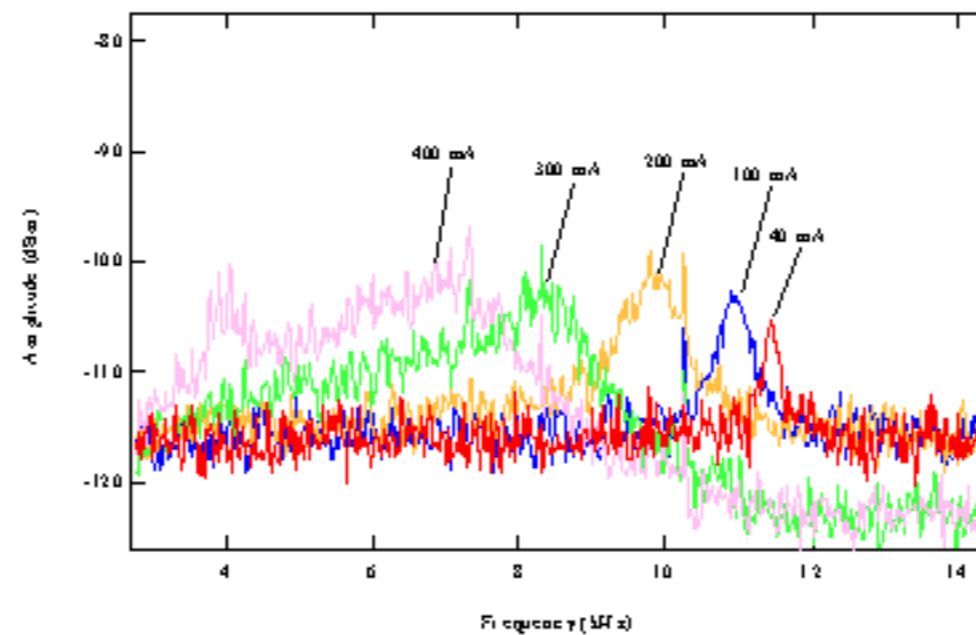

The sync. freq decreases as the beam current is increased and the cavities voltage builds up. Nominal value of 11.8 kHz. The synchrotron tune spread also increases. We have observed shifts down to 5 kHz.

Landau damping of longitudinal instabilities

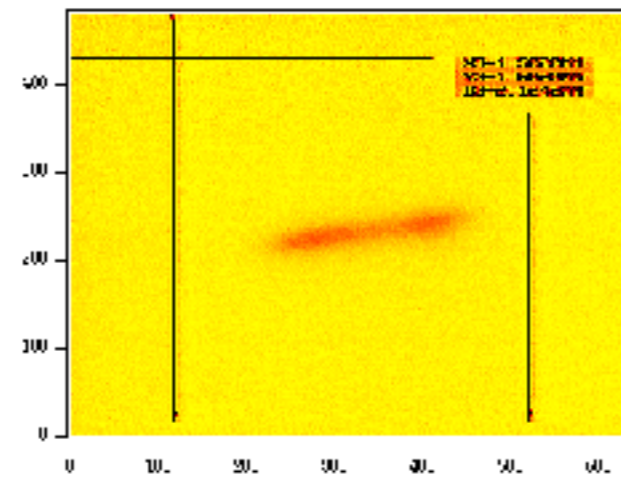

~310 mA @ 1.5 GeV

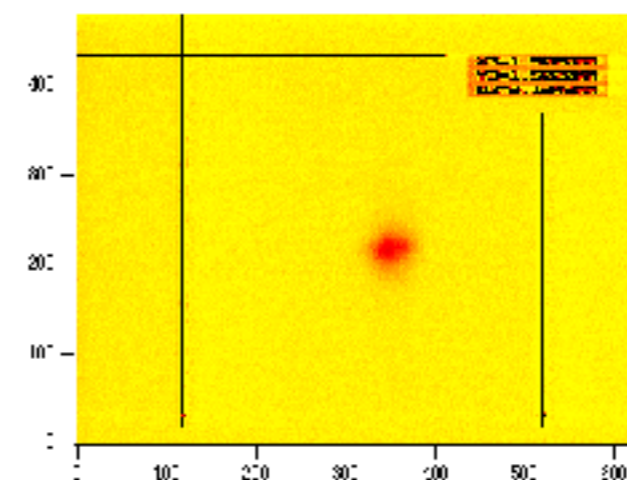

~350 mA @ 1.5 GeV

LFB is off. As the cavity voltage increases the beam gets longitudinally (almost) stable.

Transients beam loading effects



The unequal filling of the ring (i.e. gaps) create a transient loading of the main and harmonic RF systems, causing bunches to be at different RF phases (i.e. different arrival times.)

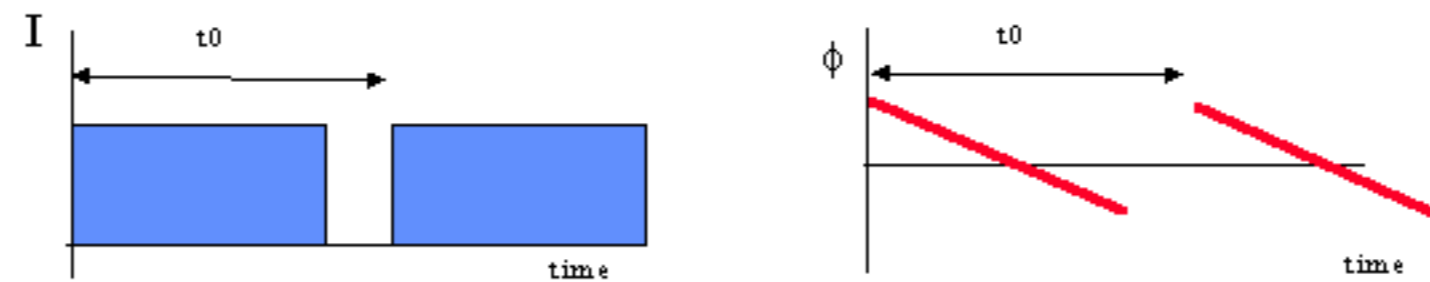

For the main RF only, this effect is small (few degrees).
With the HCs, the effect is much larger. This affects both the lifetime improvement and operation of the multibunch feedback systems.

Transient effects (cont.)



With the HCs, the longitudinal restoring force is significantly reduced, making the stable phase much more sensitive to variations in the harmonic voltage.

This has several undesirable effects:

- reduction of overall lifetime improvement
- bunches have different longitudinal shape
- bunches have different arrival times (this strongly affects the LFB system.)
- bunches have different synchrotron frequencies (possibly a benefit)

So far, our best results have been obtained with a 2% gap (320/328 bunches)

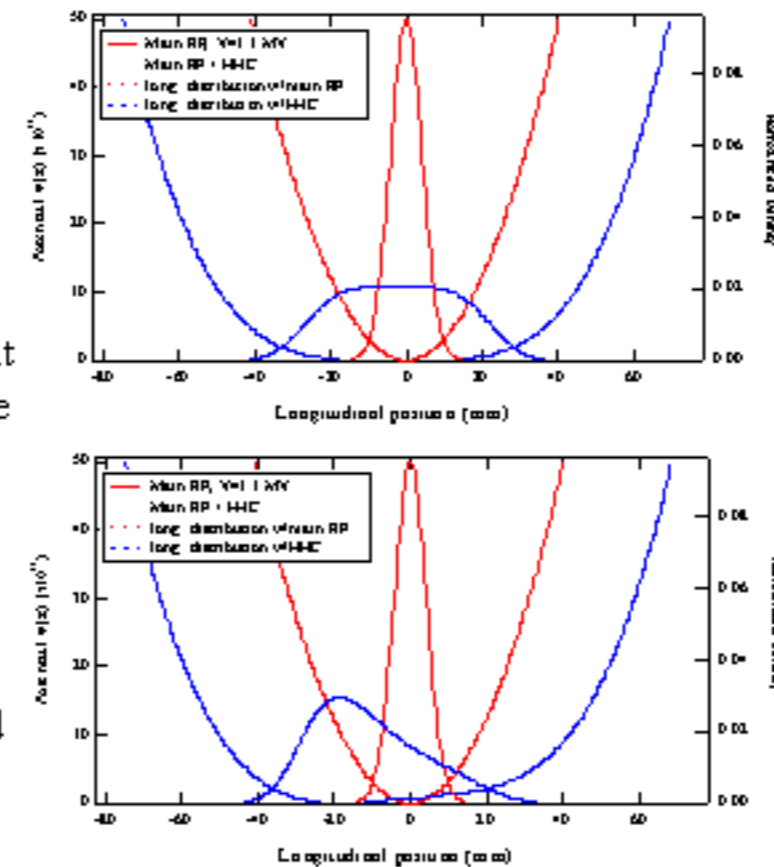

Effects on Multibunch FB systems



Synchronous phase transients:

- both LFB and TFB systems use synchronous detection schemes tuned to 3 GHz. Phase transients larger than ± 15 deg can reduce the FB gain. This solved for TFB by modifying receiver to detect using bunch signal itself.
- the phase transient can saturate the input range of the LFB. This can only be solved by detecting at a lower frequency (i.e. 1.5 GHz)

Synchrotron frequency variation:

- The LFB uses a digital signal processor implementing a filter tuned to the synch. freq. For changes in the the synch. freq., the filter must be properly adjusted to maintain damping.

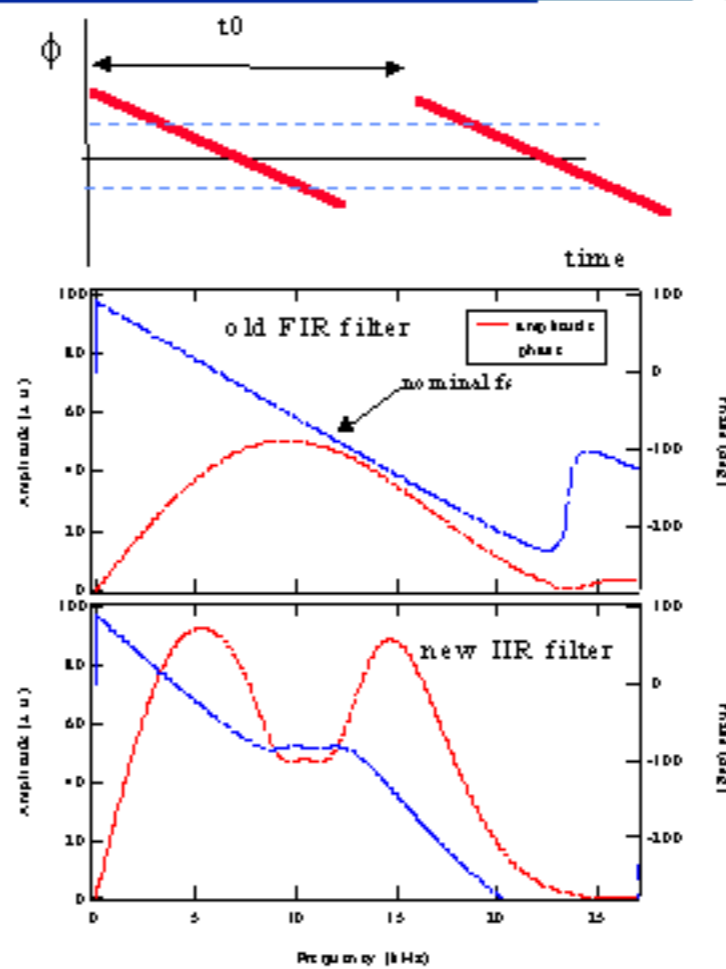

Observation of Phase Transient



2 cavities in Landau mode
3 parked at $\pm 1.5\sigma$

3 cavities in Landau mode
2 parked at $\pm 2.5\sigma$

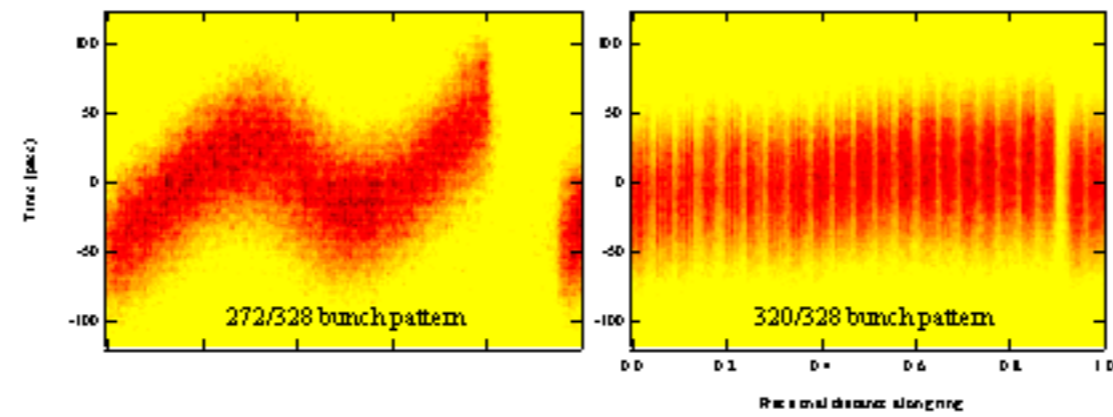

Unequal fill or gap of 20-25% (users' demand) aggravates this problem.

Phase transient (cont.)



We can extract the bunch length and relative synchronous phase along the bunch train.

The oscillations in the phase are caused by the “parked” cavities. The general slope is from the lengthening cavities.

The variation in bunch length can be best understood using simulations.

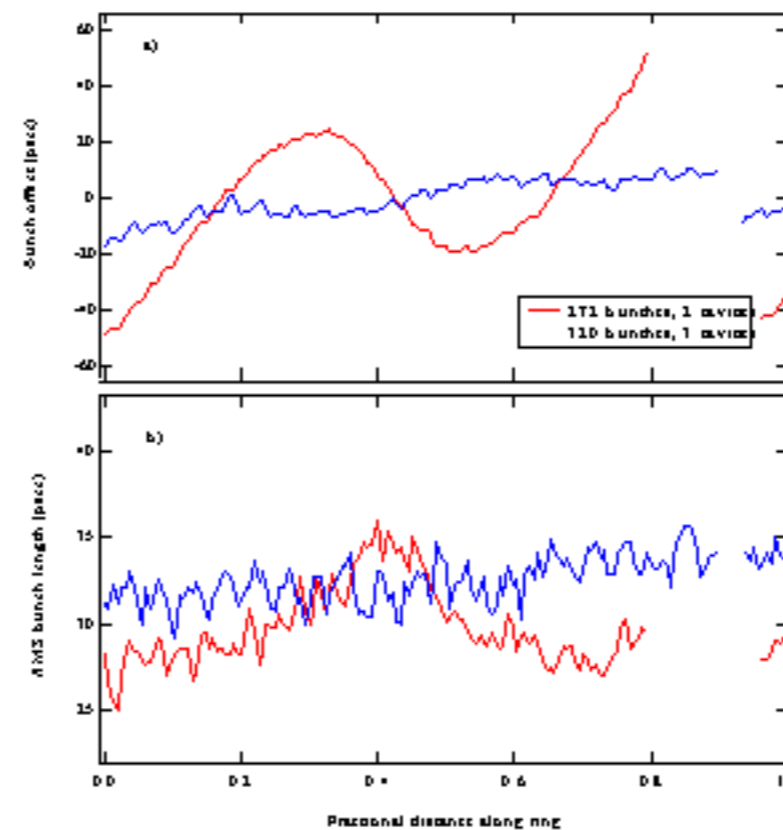

Transient simulations



Transient effects are difficult to calculate analytically due to strong perturbation of beam dynamics by harmonic voltage.

Use tracking of rigid multiple bunches to find harmonic voltage and phase and beam phase along the bunch train. Use these to calculate bunch shape along the train.

Tracking can be done for arbitrary fill patterns with arbitrary tuning of harmonic cavity fundamental. So far we've neglected transients in the main cavity fundamental.

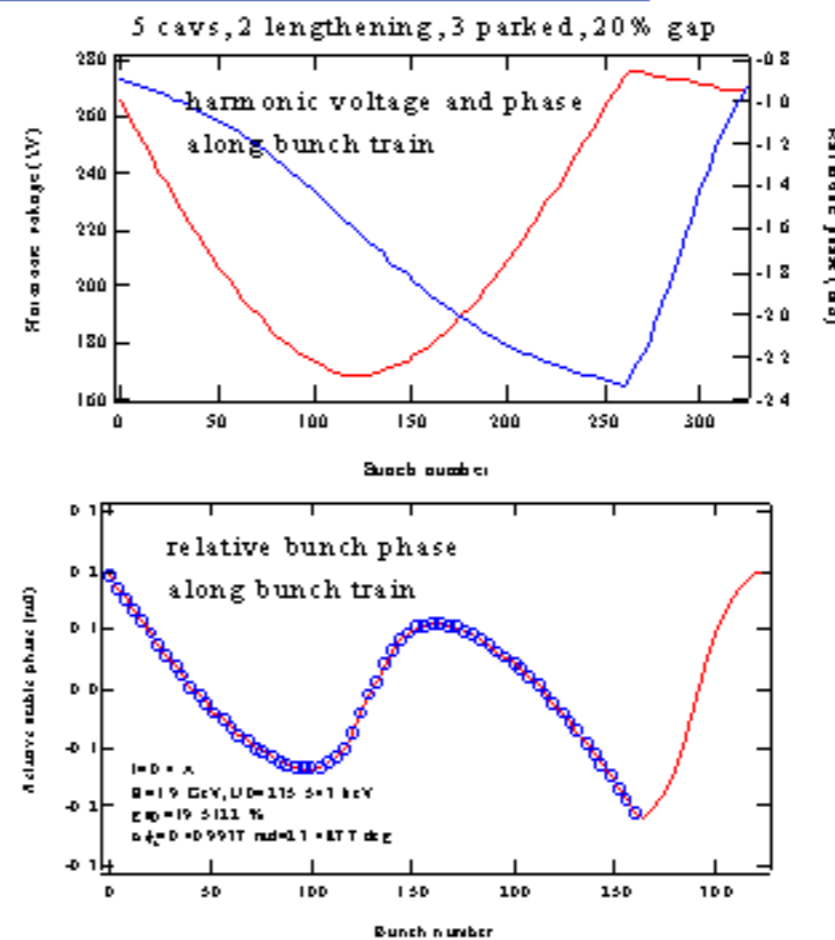

Transient simulations (cont.)



The transients are much smaller for a 2% gap. They disappear completely for no gap.

Initial simulation results indicate that the transient is similar for SC harmonic cavities. This still requires further study.

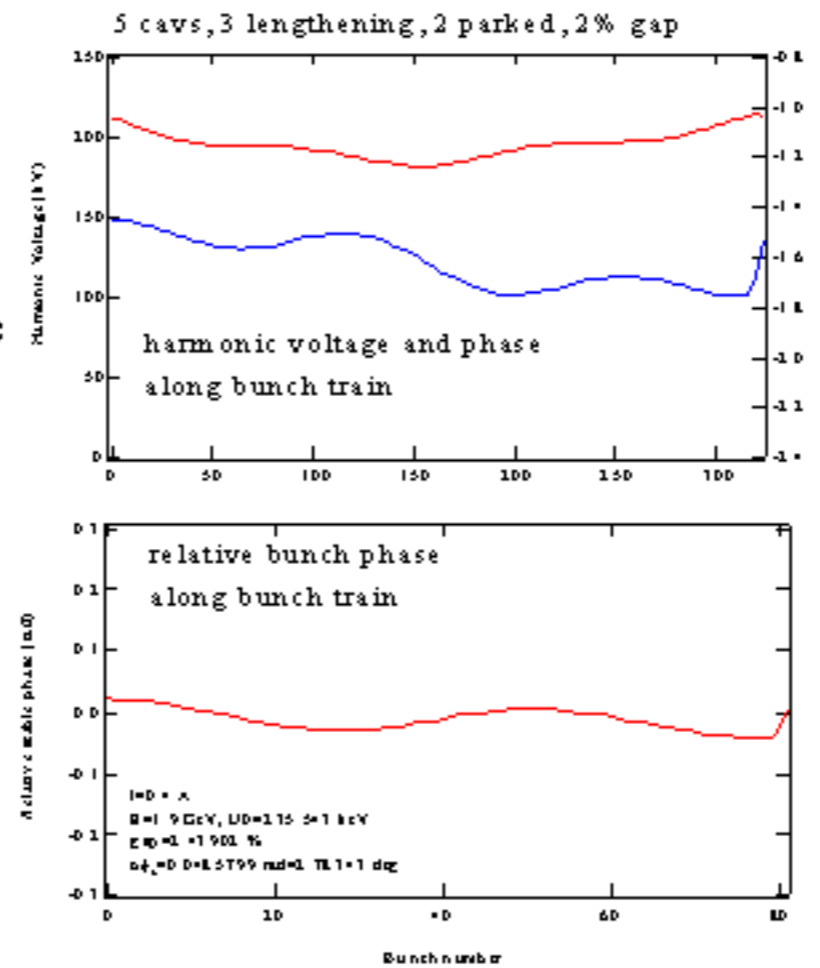

Transient simulations (cont.)



From the harmonic voltage and phase, we can calculate the bunch shape and relative lifetime increase along the bunch train.

Large transients result in large variations of the bunch length resulting in small lifetime improvement. Transient effects become more severe as the bunch is further lengthened.

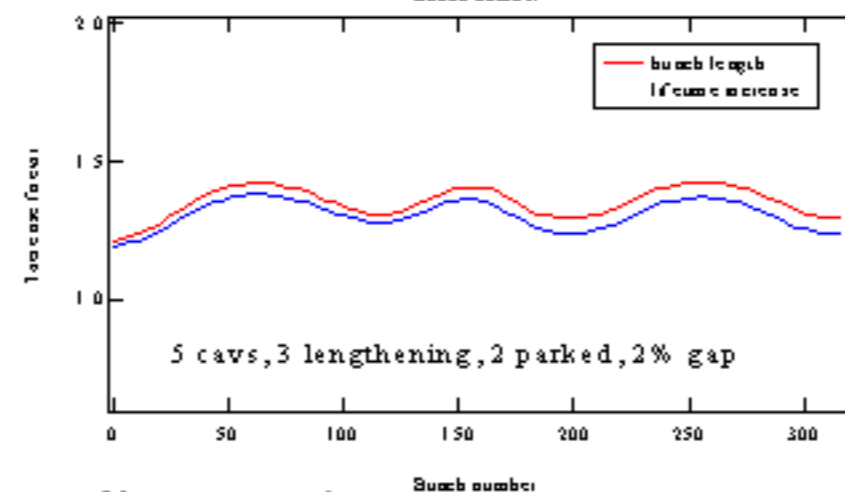
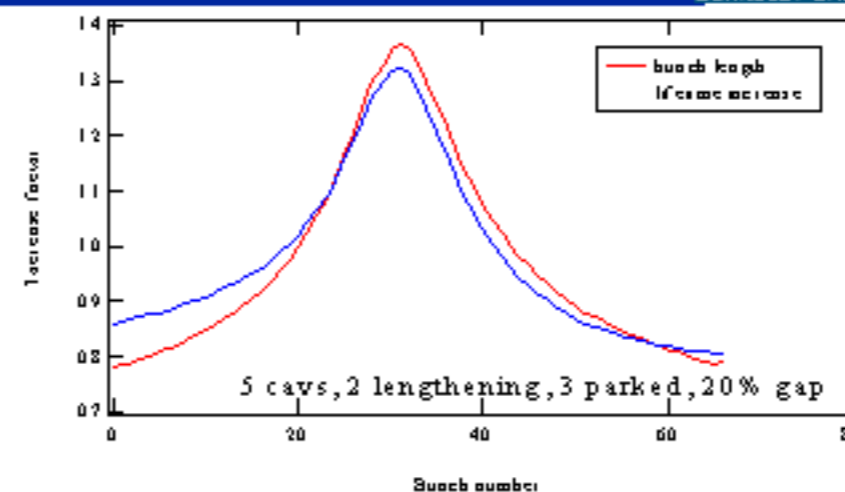

Mode tuning



The high-Q cavity modes can be tuned using the single bunch spectrum excited in the cavity probe. The Q and frequency can be found to fairly high accuracy using this method.

We regularly use this technique to tune the fundamental and TM011 (first monopole HOM).

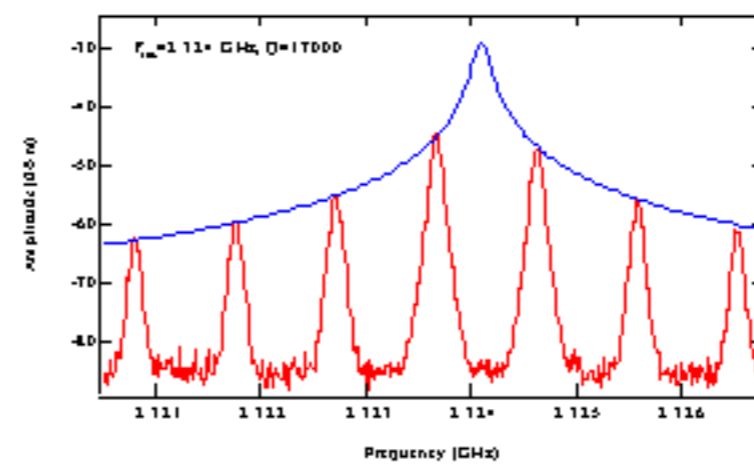
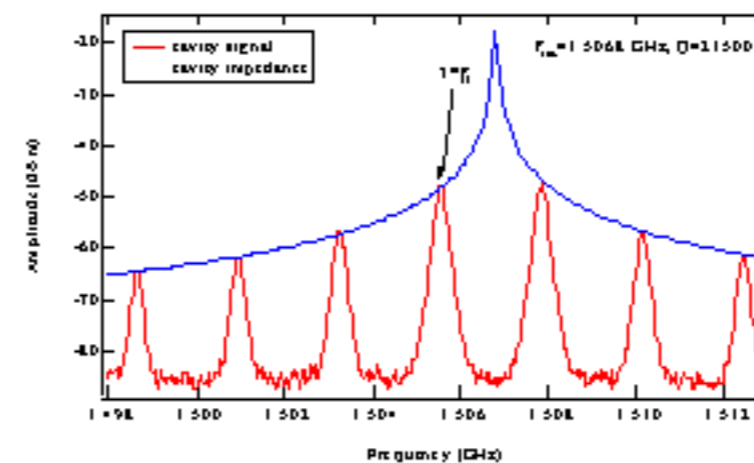

Cavity HOMs



- HOM Q's depend strongly on the tuners position.
- Beam pipe cut-off at 3.5 GHz.

Meas. Freq [GHz]	Calc. Freq [GHz]	Meas. Q	Calc. Q	Calc. R/Q	R [k Ω]	Mode
<u>monopole modes</u>						
2.295	2.319	3100	23500	36.8	114	0-M-1
<u>dipole modes</u>						
					R [M Ω /m]	
1.948	1.940	6000	11700	37.3	8.81	1-M-1v
1.915	1.915	5200	26500	1.4	0.29	1-M-1h
2.272	2.270	3500	26700	0.37	0.04	1-E-1v
2.334	2.336	6000	18500	10.3	2.02	1-E-1h
2.918	2.915	1000	22300	13	0.34	1-M-2v
2.921	2.926	5400	24400	0.24	0.03	1-M-2h

Aluminium test model

HOM Damping



- Damping not developed initially in order to make June 1999 installation.
- Tuning alone too difficult. Too many HOMs for two tuners.
- We have installed a flange w/ brazed ferrite tile on the input port of each cavity to damp higher frequency HOMs. Results indicate much greater vertical stability. Remaining modes (fundamental and TM011) can be tuned independently.

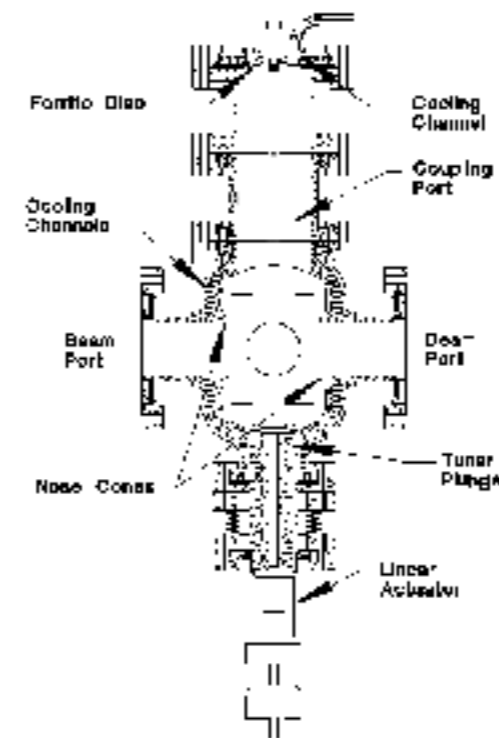

HOM damping (cont.)

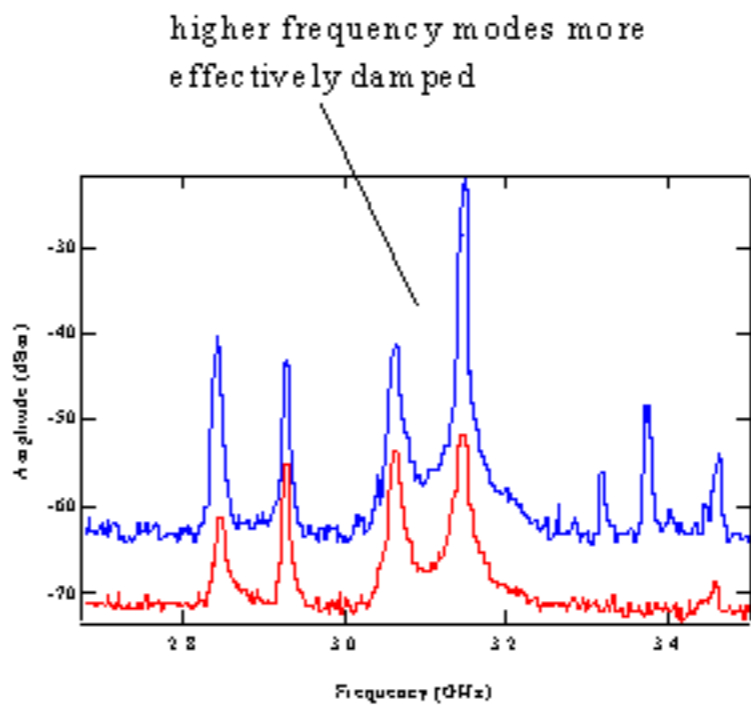
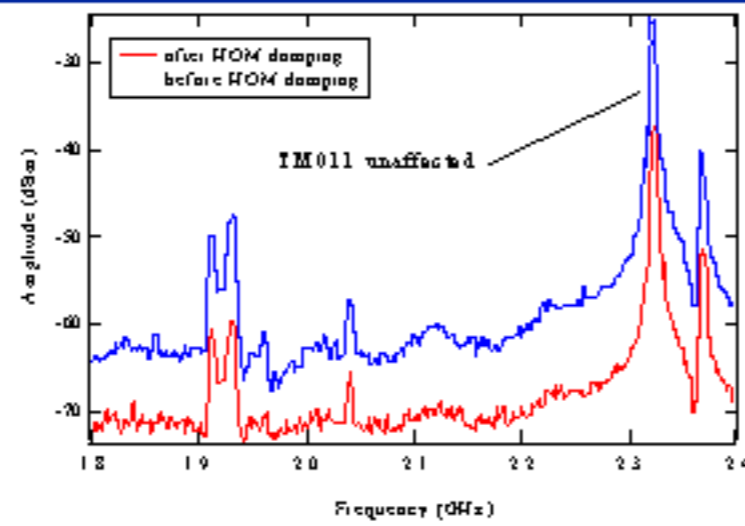

Summary



- 400 mA stable beam with 10 hr lifetime w/small beam gap.
- Added ~50% lifetime improvement to normal operations w/two cavities. Allow 6 hr 400 mA-200 mA. Limited by phase transient.
- Identified problems limiting full current with maximum bunch lengthening
 - harmonic cavity HOMs
 - damping installed in all 5 cavities
 - synchronous phase transients
 - smaller gaps in fill pattern
 - modify LFB to detect at lower frequency
 - overall reduction of potential lifetime increase
 - synchrotron frequency variation
 - optimize LFB software-how?
 - add diagnostics to check for proper adjustment